

***P*PLUSIVO**

Mastering The Art of Measurement

User Guide for the Plusivo
DM401B Multimeter

Table of Contents

Introduction	3
1. Overview	3
2. Parts	4
2.1 Display	5
2.2 Function keys description	6
3 Reference Table	7
3.1 Table of SI Units	7
3.2 Table of Prefixes	7
4. Technical Specifications	8
4.1 Accuracy Specifications	8
4.2 DC Voltage	8
4.3 AC Voltage	8
4.4 AC/DC Current	8
4.5 Resistance	9
4.6 Capacitance	9
4.7 Frequency/Duty	9
4.8 Diode/Continuity	10
4.9 Temperature	10
5. Instrument Operation	10
5.1 Power On/Off	10
5.2 Gear Selection	10
5.3 Data Hold	10
5.4 Flashlight	10
5.5 Backlight	10
5.6 Blown-Fuse Indicator	11
5.7 Input Jack Indicator	11
5.8 Automatic Current Identification	11
5.9 Automatic Shutdown	11
6. Measurement Operation	11
6.1 Smart (AUTO) Measurement	11
7. Professional Measurement	12
7.1 AC/DC Voltage Measurement	12
7.2 Resistance Measurement	13
7.3 Continuity Measurement	14
7.4 Frequency/Duty Measurement	15
7.5 Capacitance Measurement	16
7.6 Diode Test	17
7.7 Temperature Measurement	18
7.8 Non-contact AC voltage (NCV) Detection	19
7.9 Live Wire Detecting	20

7.10 AC/DC Current Measurement	21
8. Basic Concepts	22
8.1 Ohm's Law	22
8.1.1 Example	22
8.2 Joule's Law for Electrical Power	25
8.2.1 Example	25
8.3 Kirchhoff's Law	27
8.3.1 Kirchhoff's Current Law	27
8.3.2 Kirchhoff's Voltage Law	28
8.3.3 Example	28
8.4 Shunt Resistor	32
8.4.1 Example	33
8.5 Choosing the Right Resistor for an LED	35
8.5.1 Example	36
8.6 Measuring Internal Resistance of a Battery	39
8.6.1 Example	40
8.7 Testing Some Components Using Multimeter	41
8.7.1 Potentiometer Test	41
8.7.2 BJT Transistor Test	43

Safety Specifications and Instructions

The meter conforms to IEC61010-1 (CAT.) III 600 V overvoltage safety standard and pollution level 2.



Caution

operation that may cause damage to equipment



Warning

operation that may cause damage to users

Before using the meter, please read the printed manual carefully (the printed one that comes with the multimeter kit) and pay particular attention to the safety information to avoid possible electric shock or personal injury.

In general, if something unusual happens or if you suspect that something is wrong or has malfunctioned, do not do anything with the product and immediately contact the seller for assistance

(email address: office@plusivo.com)

Introduction

In this guide, you are going to learn how to measure DC voltage and AC voltage, AC and DC current, resistance, diodes, frequency/duty, capacitance, temperature and continuity test using DM401B 6000 Counts T-RMS Smart Digital Multimeter. You are also going to learn how to use the Non Contact AC voltage test and the live wire test. We are going to study some basic concepts like Ohm's Law and Kirchhoff's Law. Please note that product color may slightly vary due to photographic lighting sources or your monitor settings.

1. Overview



This meter is a true RMS smart digital multimeter. It has an intelligent and professional measurement function. Full function, with gear display, analog bar with multiple displays. This smart digital multimeter can be used to measure DC voltage and AC voltage, AC and DC current, resistance, diodes, frequency/duty, capacitance, temperature and do continuity tests. It can also be used as a Non Contact AC Voltage tester and has live wire test functions. The large display and function layout show clearer and better user experience. It is the best choice for professional electricians, enthusiasts and families.

Please take the time and read the printed operating instructions manual that is inside the kit before use and pay attention to the safety information and retain them for future reference. Failure to follow these instructions may lead to serious injury and damage to property.









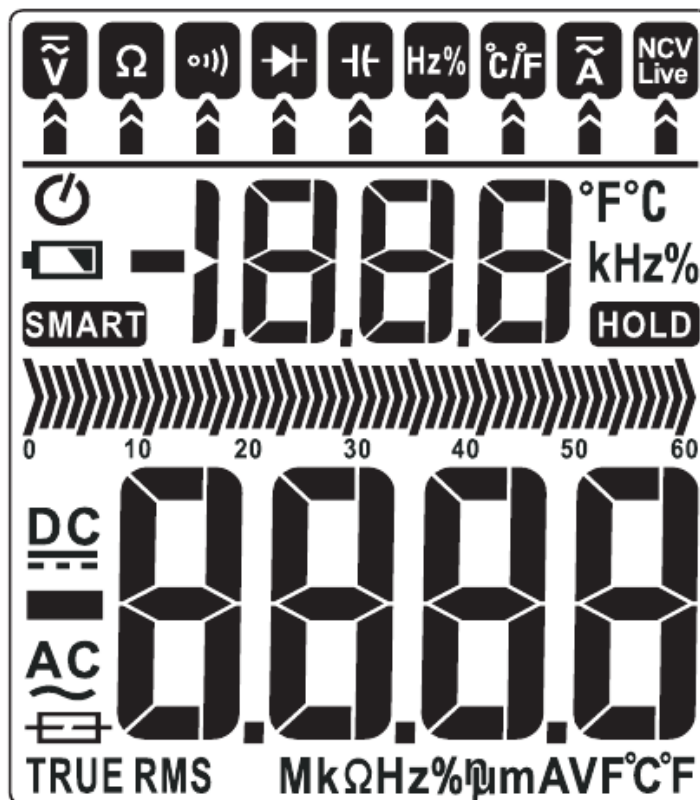

In general, if something unusual happens or if you suspect that something is wrong or has malfunctioned, do not do anything with the product and immediately contact the seller for assistance (email address: office@plusivo.com)







2. Parts



2.1 Display





	AC / DC Voltage measurement
	Resistance measurement
	Continuity measurement
	Diode measurement
	Capacitance measurement
	Frequency measurement
	Temperature measurement
	AC / DC Current measurement
	Non Contact Voltage Test
	Live Wire Test

	Alternating current measurement
	Direct current measurement
	Blown-fuse indicator
	Negative input polarity
	Low battery indicator
SMART	Auto measurement activated
HOLD	Hold function activated
	Auto power off indicator
mV, V	Voltage unit
μA, mA, A	Current unit
Ω, kΩ, MΩ	Resistance unit
kHz	Frequency unit
mF, nF, μF	Capacitance unit
°C, °F	Temperature measurement (Celsius, Fahrenheit)

2.2 Function keys description



FUNC	Function Key to switch between measurements
SMART	Function for Smart (auto) measurement
SEL / 	Select key / Flashlight function
	Power button
H ,	Hold Function for data or reading retention

3. Reference Table

3.1 Table of SI units

Quantity	SI Unit	Abbreviation
Voltage	Volts	V
Current	Ampere	A
Power	Watt	W
Energy	Joule	J
Electric charge	Coulomb	C
Resistance	Ohm	Ω
Capacitance	Farad	F
Inductance	Henry	H
Frequency	Hertz	Hz

3.2 Table of prefixes

Prefix	Power	Numeric Representation
Tera (T)	10^{12}	1 trillion
Giga (G)	10^9	1 billion
Mega (M)	10^6	1 million
Kilo (k)	10^3	1 thousand
No prefix	10^0	1 unit
Milli (m)	10^{-3}	1 thousandth
Micro (μ)	10^{-6}	1 millionth
Nano (n)	10^{-9}	1 billionth
Pico (p)	10^{-12}	1 trillionth

4. Technical Specifications

- Using condition: CAT. III 600 V;
Pollution Level 2, Altitude <2000 m;
Working temperature and humidity:
0~40°C (<80% RH, <10°C non-considering);
Storage temperature and humidity:
-10~60°C (<70% RH, remove the battery)
- Temperature coefficient: 0.1 x accuracy / °C (<18°C or >28°C);
- MAX. Voltage between terminals and earth ground: DC/ AC 600 V;
- Fuse protection: F10 A/250 V fuse
- Sampling rate: approx. 3 times/second
- Display: 6000 counts
- Over range indication: "OL".
- Low battery indication "  " will be displayed.
- Input polarity indication: display "-".
- Power requirement: 4 x 1.5 V AAA batteries.

4.1 Accuracy specifications

The accuracy applies within one year after the calibration. Reference condition: ambient temperature from 18°C to 28°C, relative humidity not more than 80%.

4.2 DC Voltage

Range	Resolution	Accuracy
600 mV	0.1 mV	± (0.5% + 3) Impedance: approx. 10 MΩ
6 V	0.001 V	
60 V	0.01 V	
600 V	0.1 V	

4.3 AC Voltage

Range	Resolution	Accuracy
6 V	0.001 V	±(0.8% +3)
60 V	0.01 V	
600 V	1 V	

Impedance: approx. 10 MΩ
Frequency response: 40 Hz~1kHz; TRMS

4.4 AC/DC current

Range	Resolution	Accuracy
600 mA	0.1 μA	±(1.2% +3)
6 A	1 μA	
10 A	0.01 mA	

Overload protection: F10 A/250 V fuse
Frequency response: 40 Hz~1k Hz; TRMS

4.5 Resistance

Range	Resolution	Accuracy
600 Ω	0.100 Ω	±(1.0% +5)
6 kΩ	0.001 kΩ	
60 kΩ	0.010 kΩ	
600 kΩ	0.100 kΩ	
6 MΩ	0.001 MΩ	
60 MΩ	0.010 MΩ	±(1.5% +10)
Overload protection: 250 V		



4.6 Capacitance

Range	Resolution	Accuracy
6 nF	0.001 nF	±(4.0% +5)
60 nF	0.01 nF	
600 nF	0.1 nF	
6 μF	0.001 μF	
60 μF	0.01 μF	
600 μF	0.1 μF	
6 mF	0.001 mF	±(5.0% +5)
60 mF	0.01 mF	
Overload protection: 250 V		

4.7 Frequency/Duty

Range	Resolution	Accuracy
6 Hz	0.001 Hz	±(1.0% +3)
60 Hz	0.01 Hz	
600 Hz	0.1 Hz	
6 kHz	0.001 kHz	
60 kHz	0.01 kHz	
600 kHz	0.1 kHz	
6 MHz	0.001 MHz	
10 MHz	0.01 MHz	
1.0~99.0%	0.1%	±(1.0% +3)
Overload protection: 250 V		

4.8 Diode/Continuity

	Diode voltage drop indicator
	Approx. 50Ω buzzer will sound and the LED will light up

4.9 Temperature

Range	Accuracy	
°C	-40°C ~ 0°C	± 3°C
	0°C ~ 1000°C	± 2.0% or ± 2°C
°F	-40°F ~ 32°F	± 6°F
	32°F ~ 1832°F	± 2.0% or ± 4°F

Resolution: 1°C/1°F
Note: use K-type thermocouple probe

5. Instrument Operation

5.1. Power On/Off

Press and hold the " " key for about 2 seconds to turn on or off.

5.2 Gear Selection

Press the " " key to select manual mode;

Press the " " key again to select the gear to left or right;

Press the " " key to return to AUTO measurement mode. By default, the power is in smart measurement mode.

5.3 Data Hold

Press " " key to turn on or off the data holding.

5.4 Flashlight

Press and hold " " key for about 2 seconds to turn on or off the flashlight.

5.5 Backlight

Press " " to turn on or off the backlight.

Note: the VA display does not have this feature.

5.6 Blown-fuse indicator

If the fuse is blown, the symbol " " will appear on the display.

When the current gear is selected, the symbol "FUSE" is displayed simultaneously. Current measurement is not allowed. Please replace the fuse in time.

5.7 Input jack indicator

When shifting gear, the corresponding input indicator will flash 5 times to prompt you to insert the probe into the appropriate socket.

5.8 Automatic current identification

When the "A" connector is inserted into the sensor, the meter will automatically shift to the " " gear and enter the current measurement function.

5.9 Automatic shutdown

Once enabled, it will default to auto power off and display " " symbol. Without any key operation for about 15 minutes, the meter will turn off automatically to save the battery power.

Press and hold the " " button to turn on the meter, the auto power off function will be canceled.



6. Measurement operation

Warning

- Do not measure voltages higher than 600 V; otherwise the meter may be damaged.
- Pay special attention to safety when measuring high voltage to avoid electric shock or injury.
- Before use, please check the known voltage with a multimeter to ensure that the multimeter is in good condition.

6.1 Smart (AUTO) measurement



This measurement mode is used by default when turned on. In this mode, DC voltage, AC voltage, resistance, continuity can be measured, and the meter can automatically identify the measurement signal.

- 1) Press the  button to turn on the power, display  and enter the smart measurement mode.
- 2) Insert the red probe into the  jack and the black test lead into the "COM" jack.
- 3) Contact the probes with both ends of the measured power or resistance (in parallel), and the meter will automatically recognize the measured signal.
- 4) When measuring resistance, if the resistance is less than about 50 Ω , the buzzer sounds and the indicator lights up.
- 5) Read the results from the display.

NOTE: The minimum measured voltage in this mode is 0.8 V.



7. Professional measurement

7.1 AC/DC Voltage Measurement

- 1) Press the  button to turn on the power, **Auto** will be displayed and will enter the smart measurement mode.
- 2) Press " " key to select " \tilde{V} " gear.
- 3) Press the " " button to select AC or DC voltage. The " $\tilde{\sim}$ " symbol on the display is the AC voltage; the " DC " symbol on the display is the DC voltage.
- 4) Insert the red probe into the $\text{HzV}\Omega\text{Live}$ jack and the black test lead into the "COM" jack.
- 5) Contact the probe with both ends of the measured power supply (parallel).
- 6) Read the results from the display.





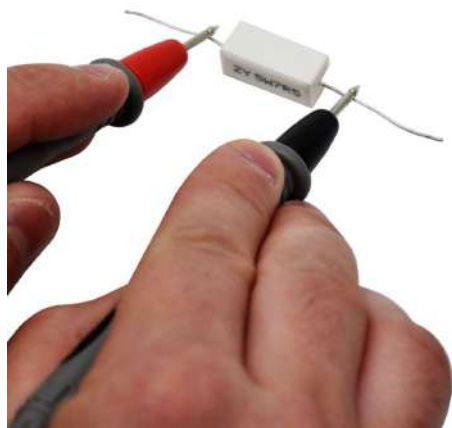

7.2 Resistance Measurement

- 1) Press the  button to turn on the power, **Auto** will be displayed and will enter the smart measurement mode.
- 2) Press " " key to select "**Ω**" gear.
- 3) Insert the red probe into the  jack and the black test lead into the "**COM**" jack.
- 4) Contact the probe with both ends of the measured power supply (parallel).
- 5) Read the results from the display.





7.3 Continuity test

- 1) Press the  button to turn on the power, **Auto** will be displayed and will enter the smart measurement mode.
- 2) Press " " key to select " " gear.
- 3) Insert the red probe into the  jack and the black test lead into the "**COM**" jack.
- 4) Contact the probe with both ends of the measured resistance or circuit (parallel).
- 5) When measuring resistance, if the resistance is less than about 50 Ω , the buzzer sounds and the indicator lights up.
- 6) Read the results from the display.





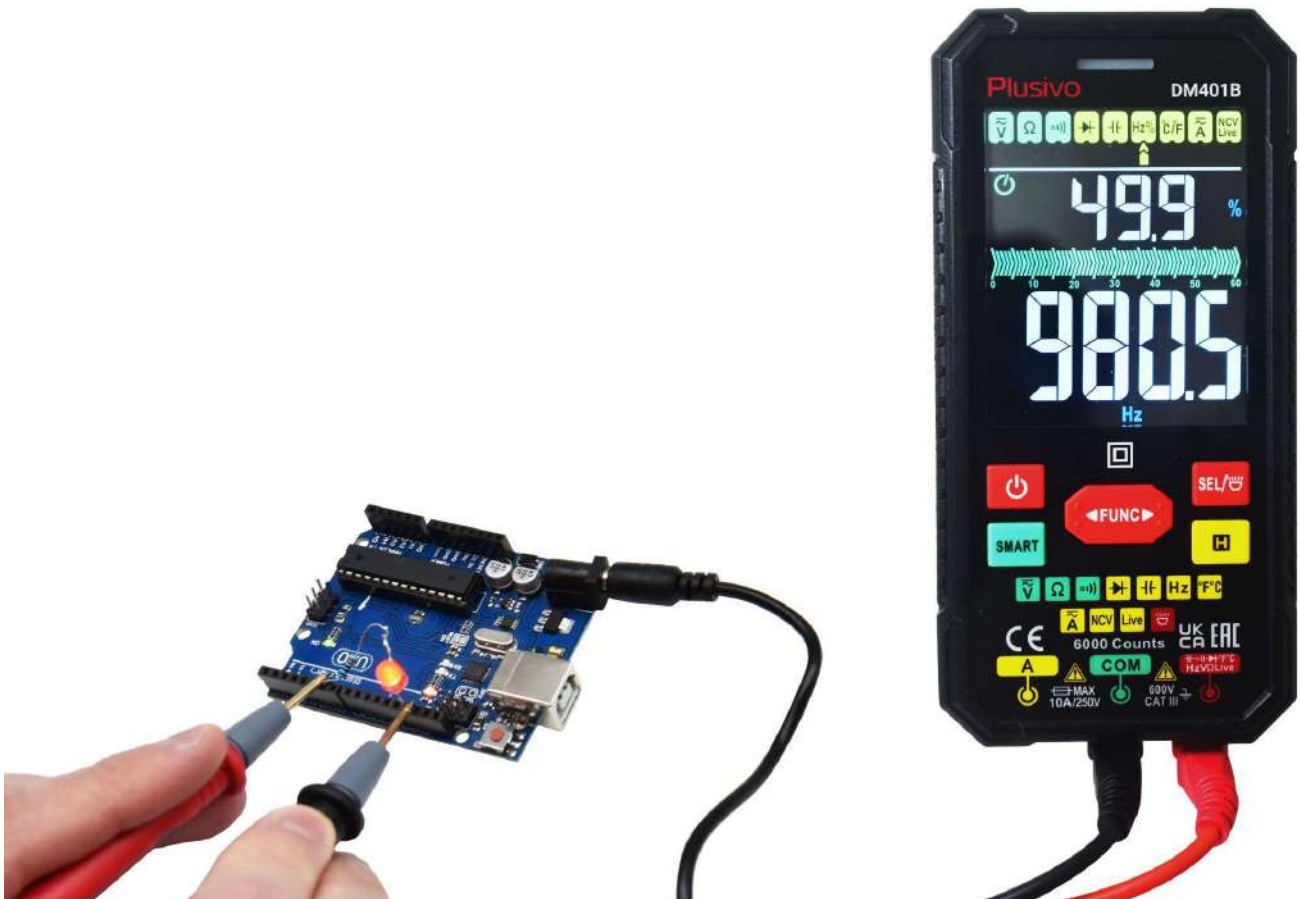

7.4 Frequency/Duty Measurement

- 1) Press the  button to turn on the power, **Auto** will be displayed and will enter the smart measurement mode.
- 2) Press "" key to select "**Hz%**" gear.
- 3) Insert the red probe into the  jack and the black test lead into the "**COM**" jack.
- 4) Contact the probe with both ends of the measured power supply (parallel).
- 5) Read the results from the display.







7.5 Capacitance Measurement

- 1) Press the  button to turn on the power, **Auto** will be displayed and will enter the smart measurement mode.
- 2) Press "" key to select "" gear.
- 3) Insert the red probe into the  jack and the black test lead into the "**COM**" jack.
- 4) Contact the probe with both ends of the measured power supply (parallel).
- 5) Read the results from the display.



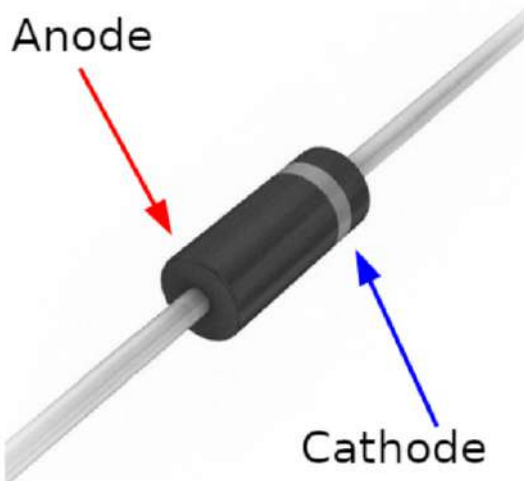

7.6 Diode test

- 1) Press the  button to turn on the power, **Auto** will be displayed and will enter the smart measurement mode.
- 2) Press " " key to select " " gear.
- 3) Insert the red probe into the  jack and the black test lead into the "**COM**" jack.
- 4) The red probe contacts the anode of the diode and the black probe contacts the cathode of the diode.
- 5) If the polarity of the sensor is opposite to the polarity of the diode, the display will show "**OL**".
- 6) Read the results from the display.





The measured forward voltage in this figure is 0.605 V

7.7 Temperature measurement

- 1) Press the  button to turn on the power, **Auto** will be displayed and will enter the smart measurement mode.
- 2) Press "" key to select "**C/F**" gear.
- 3) Insert the red probe into the  jack and the black test lead into the "**COM**" jack.
- 4) The thermocouple probe contacts the measured object
- 5) Read the results from the display.







7.8 Non-contact AC voltage (NCV) detection

- 1) Press the  button to turn on the power, **Auto** will be displayed and will enter the smart measurement mode.
- 2) Press " " key to select "**NCV** Live " gear. The "**NCV**" symbol will be displayed.
- 3) Gradually approach the **NCV** sensor area to the conductor.
- 4) When the weak electric field signal is detected, it will display "---L"; the sound of the buzzer will slow down and the green light will turn on.
- 5) When the strong electric field signal is detected, it will display "---H"; the buzzer will sound fast and the red light will turn on.









7.9 Live wire detecting

- 1) Press the  button to turn on the power, **Auto** will be displayed and will enter the smart measurement mode.
- 2) Press " " key to select " **Live** " gear. Press the " " key to display the "**LIVE**" symbol.
- 3) Insert the red probe into the  **Live** jack and remove the black probe.
- 4) Use the red probe to contact the conductor.
- 5) When the weak electric field signal is detected, it will display "---L"; the sound of the buzzer will slow down and the green light will turn on.
- 6) When the strong electric field signal is detected, it will display "---H"; the buzzer will sound fast and the red light will turn on.



7.10 AC/DC current measurement

- 1) Press the "  " button to turn on the power, "Auto" will be displayed and will enter the smart measurement mode.
- 2) Press "  " key to select "  " gear. Or insert the red probe into the **A** jack to automatically select the "  " gear.
- 3) The symbol "  " on the display means DC current measurement; press the "  " button to display the "  " symbol, which is AC current measurement.
- 4) Insert the red probe into the **A** jack and the black probe into the **COM** jack.
- 5) Disconnect the measured power supply, after that connect the meter in series with the power supply, and then turn on the measured power supply.
- 6) Read the results from the display.



Caution!

Do not measure current greater than 10 A, otherwise the fuse will be blown.

If you want to do AC current measurement, press the "  " button to shift to AC current measurement function.

8. Basic Concepts

8.1 Ohm's Law

It is a law that illustrates the relationship between the voltage, the current, and the resistance.

$$V = I \cdot R$$
$$R = \frac{V}{I}$$
$$I = \frac{V}{R}$$

I is the current through the resistor.

V is the voltage around the resistor.

R is the resistance.

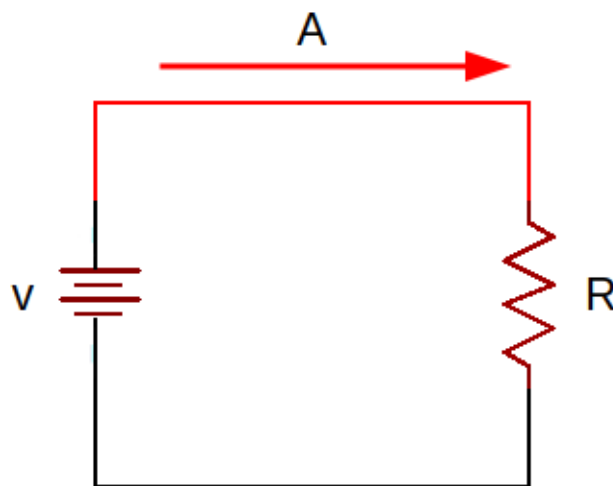

8.1.1 Example

Calculate the current in this circuit.

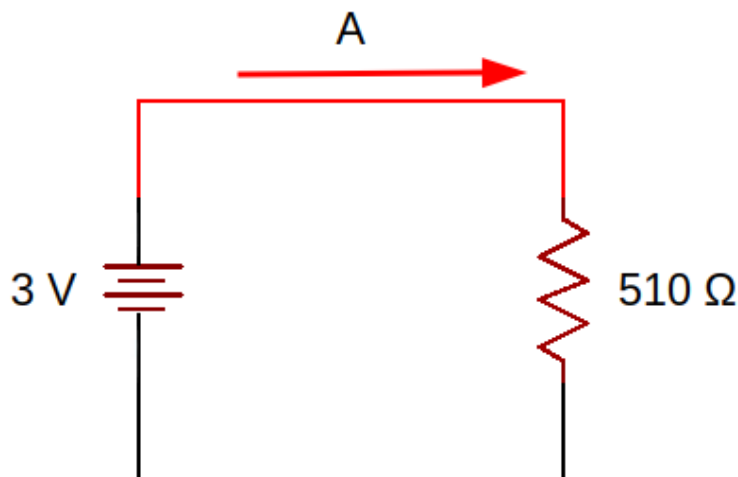

Simply, we can use Ohm's law: $I = \frac{V}{R}$

$$\frac{3V}{510\Omega} = 0.00588 A = 5.88 mA$$

If we built this circuit in reality and measure the current using the multimeter as in the following schematic:

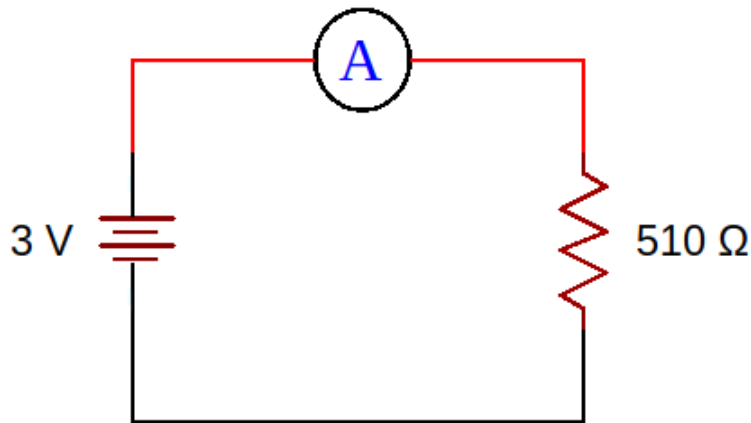

We should read on the screen of the multimeter: **5.88 mA**

But this is if we have an ideal circuit, in reality, we will not get this specific value because each component in this circuit has tolerance, for example, if we measure the resistance:



The measured resistance in this figure is **550.2 Ω**.

Note:

Disconnect the battery when measuring the resistance, otherwise, the multimeter may be damaged.

If we measure the voltage around the resistor:



The measured voltage in this figure is 3.087 V DC.

If we calculate the new values: $\frac{3.087 \text{ V}}{550.2 \Omega} = 5.61 \text{ mA}$

Based from the result of the calculation, the value is near the theoretical value of 5.88 mA

But in reality, it will be less than 5.61 mA because of the resistance of the multimeter itself:

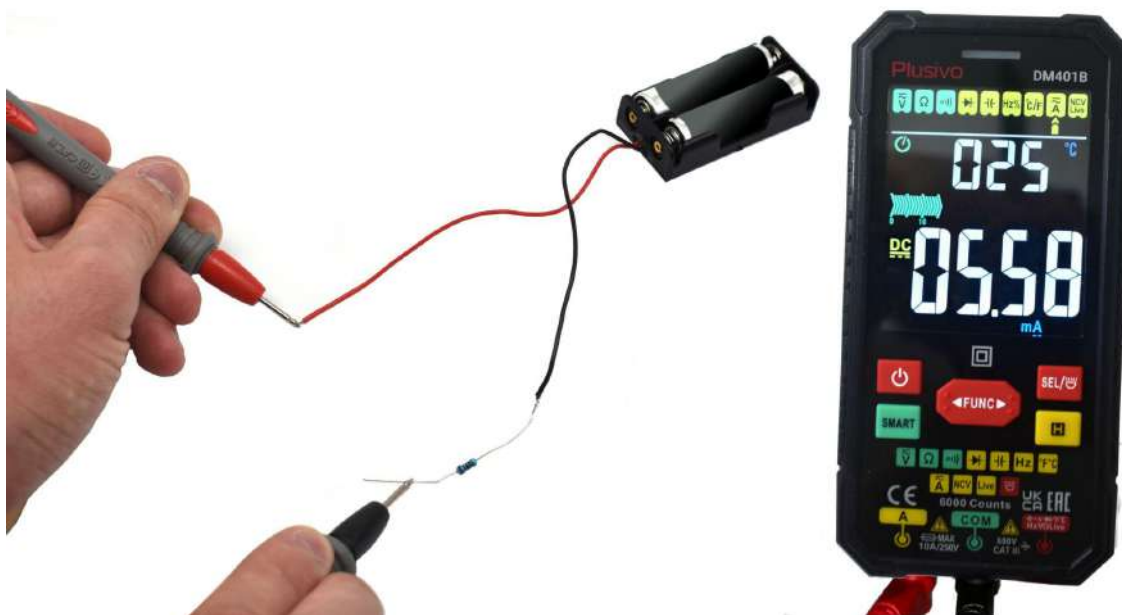

But indeed, we can count on our calculation " $3 \text{ V} / 510 \Omega = 5.88 \text{ mA}$ " because 5.88 mA is almost equal to 5.61 mA.

8.2 Joule's Law for Electrical Power

Electric power is the rate of the emitting power from a resistor per unit time, the unit of power is watt.

$$P = I \cdot V$$
$$P = I^2 \cdot R$$
$$P = \frac{V^2}{R}$$

P is the power on the resistor.

I is the current through the resistor.

V is the voltage around the resistor.

R is the resistance.

Note: There are many types of emitting power, it may be a rotary power, light, heat, etc.

8.2.1 Example

Calculate the power on the resistor.

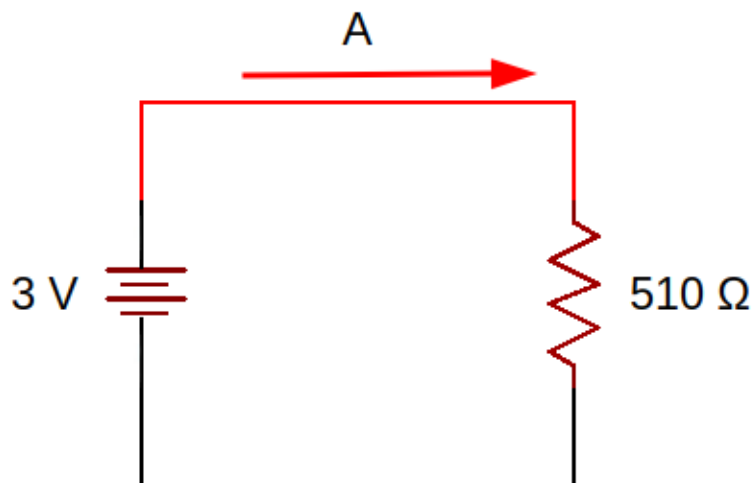

To calculate the power on the resistor, we need any two values of these: **Voltage**, **Current** or **Resistance**.

In our example, we have the voltage and the resistance, so we can use this formula:

$$P = \frac{V^2}{R}$$
$$\frac{(3 V)^2}{510 \Omega} = 0.0176 W = 17.6 mW$$

Let us see what we will get if we built this circuit in reality and calculate the power using the multimeter.



The measured resistance in this figure is 550.2 Ω

Note:

Disconnect the battery when measuring the resistance, otherwise, the multimeter may be damaged.



The measured voltage in this figure is 3.087 V DC.

So if we calculate the new values: $\frac{(3.087 \text{ V})^2}{550.2 \Omega} = 17.3 \text{ mW}$

We can count on our calculation “ $\frac{(3 \text{ V})^2}{510 \Omega} = 0.0176 \text{ W} = 17.6 \text{ mW}$ ” because the theoretical value of 17.6 mW is near the value of 17.3 mW.

If we want to use the current to calculate the power.

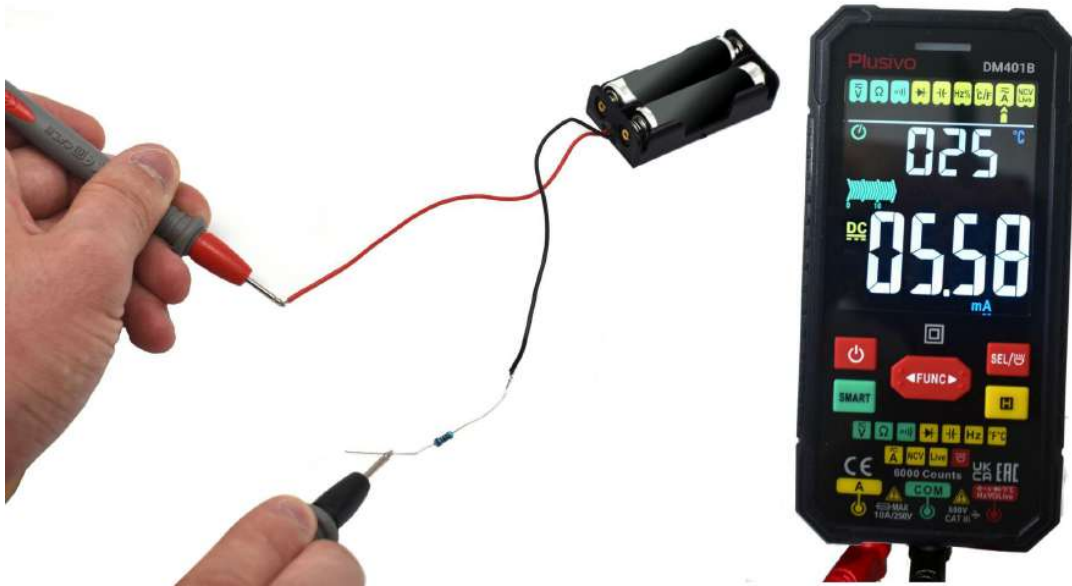

The measured current in this figure is 5.58 mA

We can use the first formula which is: $P = I \cdot V$

$$5.58 \text{ mA} \cdot 3.087 \text{ V} = 0.0172 \text{ W} = 17.2 \text{ mW}$$

And the second formula which is: $P = I^2 \cdot R$

$$(5.58 \text{ mA})^2 \cdot 510 \Omega = 0.0159 \text{ W} = 15.9 \text{ mW}$$

So all the result of the calculations using the formulas above are near each other's value: 17.3 mW, 17.2 mW, 15.9 mW

8.3 Kirchhoff's Law

8.3.1 Kirchhoff's Current Law

Currents entering the node equals currents leaving the node.

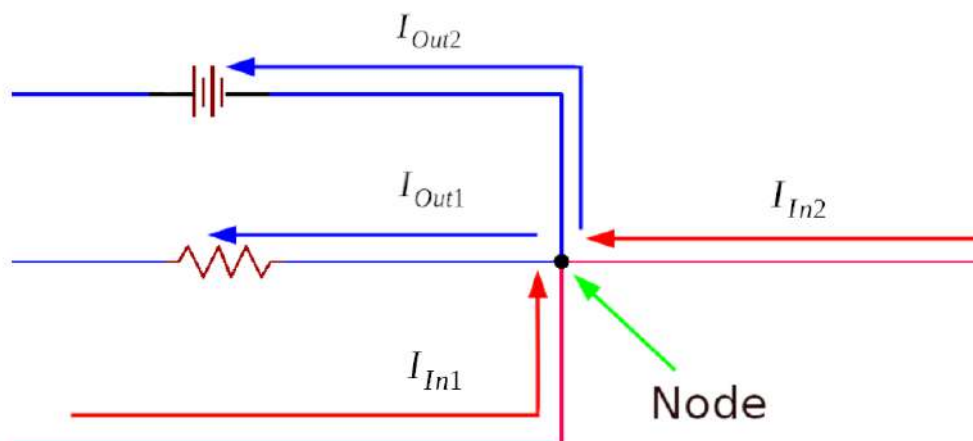

$$I_{In1} + I_{In2} = I_{Out1} + I_{Out2}$$

8.3.2 Kirchhoff's Voltage Law

The sum of all the voltages around the loop is equal to zero.

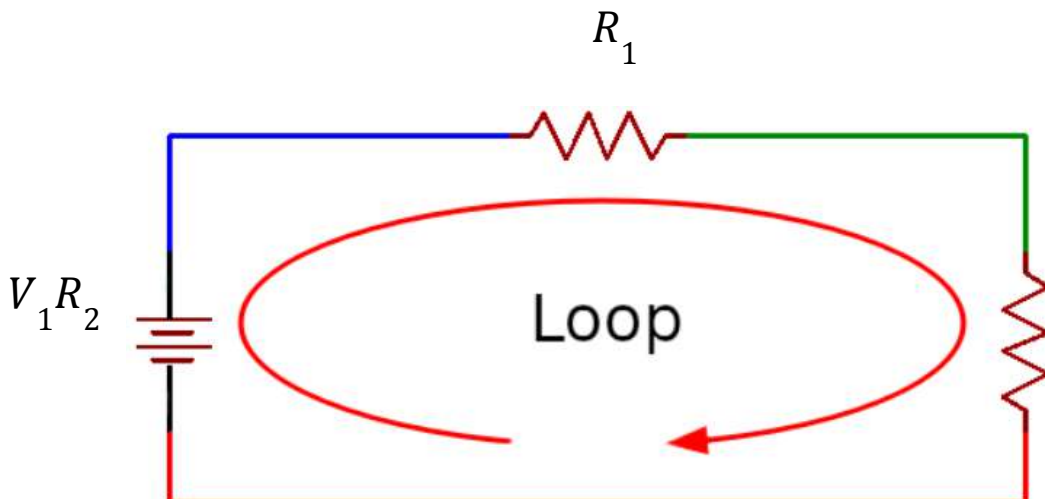

8.3.3 Example

Calculate the voltage around the resistors.

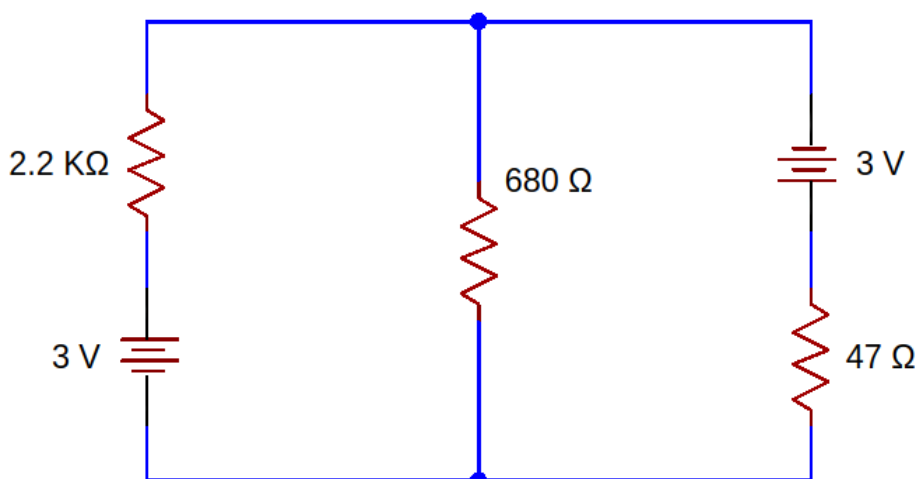

In this case, we are going to use Kirchhoff's law, we need to suppose the paths for off the current to use Kirchhoff's current law, and we need to suppose two loops to use Kirchhoff's voltage law.

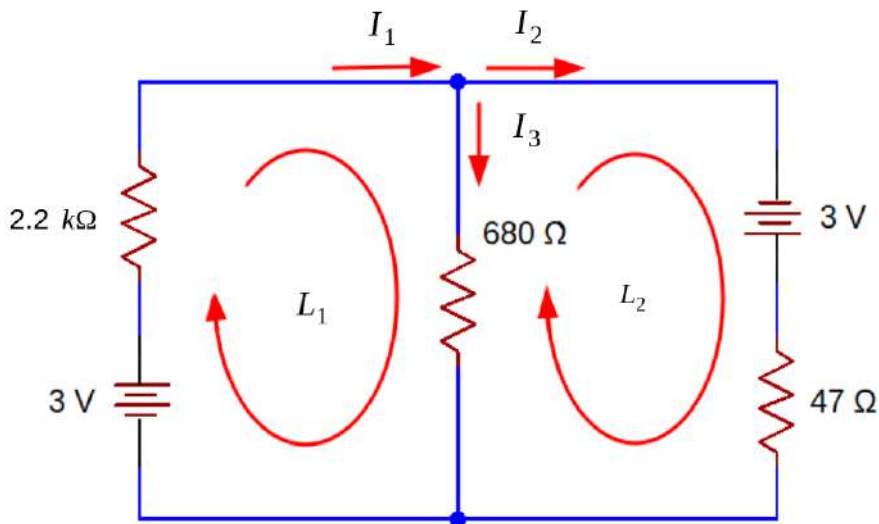

To use Kirchhoff's voltage law, we need to know some rules, for example, in L_1 if the loop passes the battery from - to + we write it in the equation (+3 V), but if the loop passes the battery from + to - we write it in the equation (-3 V). Let us take 2.2 k Ω resistor as an example, if the loop passes the resistor in the same direction with the current we write it $\left(- 2.2 \text{ k}\Omega \cdot I_1\right)$, but if the loop passes the resistor in the opposite direction with the current we write it $\left(+ 2.2 \text{ k}\Omega \cdot I_1\right)$.

We get this equation from L_1 .

$$\text{Equation 1: } 3 \text{ V} - (I_1 \cdot 2.2 \text{ k}\Omega) - (I_3 \cdot 680 \Omega) = 0 \text{ V}$$

We get this equation from L_2 .

$$\text{Equation 2: } (I_3 \cdot 680 \Omega) + 3 \text{ V} - (I_2 \cdot 47 \Omega) = 0 \text{ V}$$

We get this equation from **the node**.

$$\text{Equation 3: } I_1 = I_2 + I_3$$

Now, let us do some math to calculate I_1 , I_2 and I_3 .

$$\text{Equation 1: } 3 \text{ V} - (I_1 \cdot 2.2 \text{ k}\Omega) - (I_3 \cdot 680 \Omega) = 0 \text{ V}$$

$$3 \text{ V} - (I_3 \cdot 680 \Omega) = I_1 \cdot 2200 \Omega$$

$$I_1 = \frac{3 \text{ V}}{2200 \Omega} - \frac{I_3 \cdot 680 \Omega}{2200 \Omega}$$

$$I_1 = 0.001363 \text{ A} - (I_3 \cdot 0.3091) \rightarrow \text{This becomes equation 4}$$

$$\text{Equation 2: } (I_3 \cdot 680 \Omega) + 3 \text{ V} - (I_2 \cdot 47 \Omega) = 0 \text{ V}$$

$$I_2 \cdot 47 \Omega = (I_3 \cdot 680 \Omega) + 3 \text{ V}$$

$$I_2 = \frac{I_3 \cdot 680 \Omega}{47 \Omega} + \frac{3 \text{ V}}{47 \Omega}$$

$$I_2 = (I_3 \cdot 14.468) + 0.0638 \text{ A} \rightarrow \text{This becomes equation 5}$$

$$\text{Equation 4: } I_1 = 0.001363 \text{ A} - (I_3 \cdot 0.3091)$$

$$\text{Equation 5: } I_2 = (I_3 \cdot 14.468) + 0.0638 \text{ A}$$

From **Equation 3:** $I_1 = I_2 + I_3$, we will use the derived I_1 and I_2 from previous calculation to get I_3 , thus,

$$0.001363 \text{ A} - (I_3 \cdot 0.3091) = (I_3 \cdot 14.468) + 0.0638 \text{ A} + I_3$$

$$- I_3 \cdot 0.3091 = (I_3 \cdot 14.468) + 0.0638 \text{ A} - 0.001363 \text{ A} + I_3$$

$$- I_3 \cdot 0.3091 = (I_3 \cdot 14.468) + 0.062437 + I_3$$

$$- 0.062437 = (I_3 \cdot 0.3091) + (I_3 \cdot 14.468) + I_3$$

$$- 0.062437 = 15.7771 \cdot I_3$$

$$I_3 = - 0.003957 \text{ A}$$

$$\text{Equation 4: } I_1 = 0.001363 \text{ A} - (I_3 \cdot 0.3091)$$

$$I_1 = 0.001363 \text{ A} - (- 0.003957 \text{ A} \cdot 0.3091)$$

$$I_1 = 0.001363 A + 0.001223 A$$

$$I_1 = 0.002586 A$$

Equation 5: $I_2 = (I_3 \cdot 14.468) + 0.0638 A$

$$I_2 = (-0.003957 A \cdot 14.468) + 0.0638 A$$

$$I_2 = -0.05725 A + 0.0638 A$$

$$I_2 = 0.00655 A$$

Do not forget that we have supposed the directions of the currents, in the final answer if we get a positive answer, like I_1 and I_2 the direction we have supposed is true, but if we get a negative answer, like I_3 the direction we have supposed is wrong, so we must reverse it.

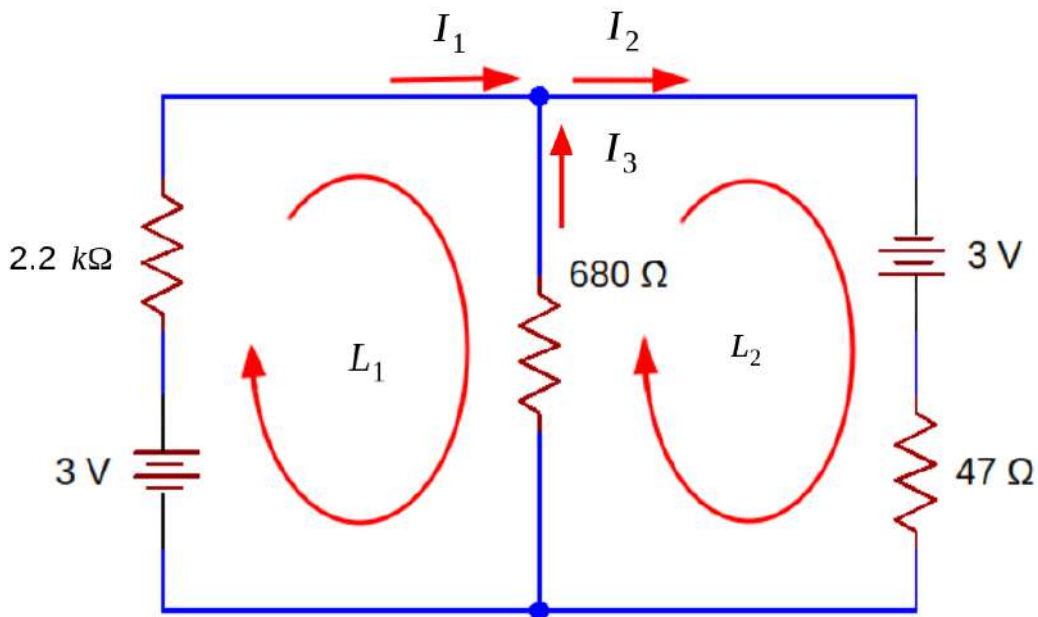

The equation $I_1 = I_2 + I_3$ will be changed to: $I_2 = I_1 + I_3$

Now, it is easy to calculate the voltage on the resistors using Ohm's law: $V = I \cdot R$

The voltage on $2.2 \text{ k}\Omega$

$$V = I_1 \cdot 2.2 \text{ k}\Omega$$

$$V = 0.002586 \cdot 2200 \Omega$$

$$V = 5.7 \text{ V}$$

The voltage on 680Ω

$$V = I_3 \cdot 680 \Omega$$

$$V = 0.003957 \cdot 680 \Omega$$

$$V = 2.7 \text{ V}$$

The voltage on 47Ω

$$V = I_2 \cdot 47 \Omega$$

$$V = 0.00655 A \cdot 47 \Omega$$

$$V = 0.3 \text{ V}$$

Now, let us make this circuit in reality and measure the voltage around the resistors using the multimeter.

The measured voltage around the 2.2 k Ω resistor is 6.087 V. Please see the set-up below.



The measured voltage around the 680 Ω resistor is 2.887 V. Please see the set-up below.



The measured voltage around the 47 Ω resistor is 0.337 V. Please see the set-up below.



So we can count on our calculation, we will always find these small differences between the calculations and the real measurements because of the tolerance of the components.

8.4 Shunt Resistor

It is a way to measure current through a bath in the circuit using a small value resistor, we cut the circuit and connect it again using the shunt resistor. In most cases, it should be a high power resistor to handle the current passing through it.

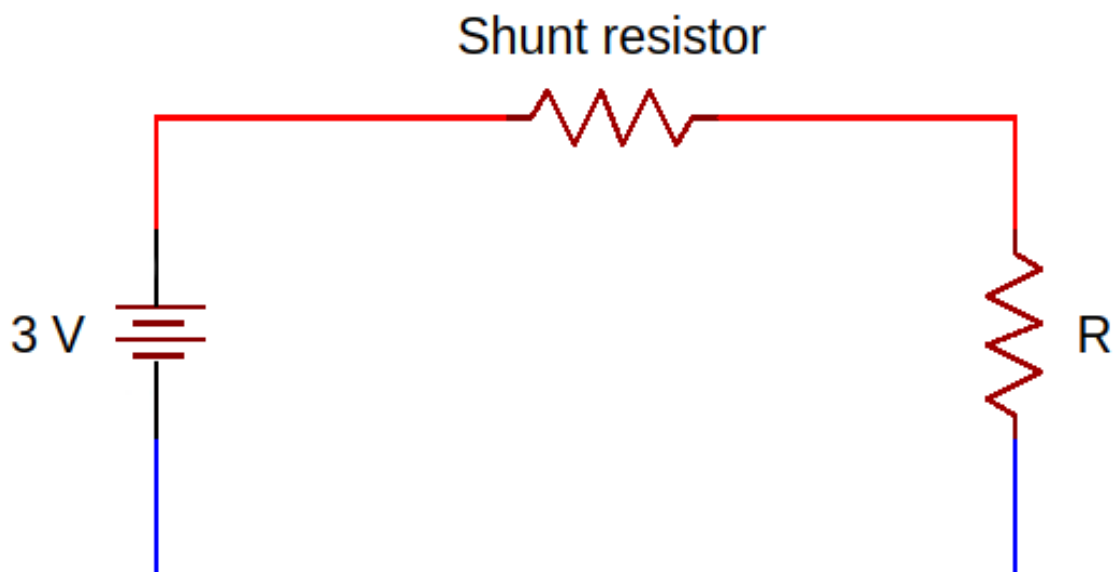

So depending on ohm's law " $V = I \cdot R$ ", we have a shunt resistor, and we have a current passing through it, so the voltage will be generated around it. And then we will measure this voltage using the multimeter, this way we have converted the current into voltage.

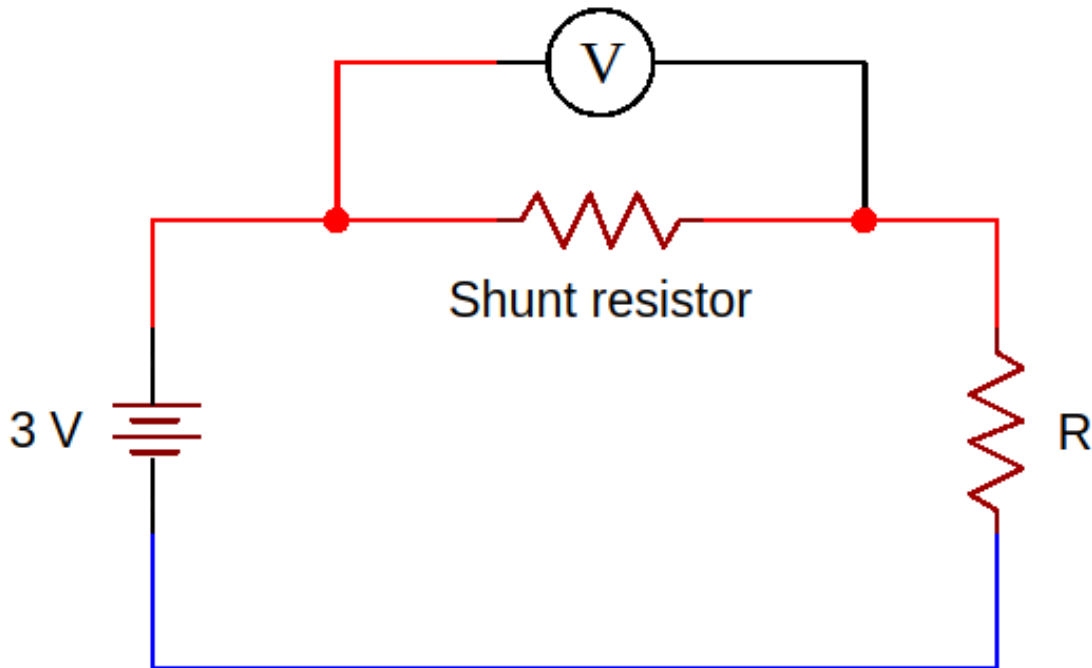

8.4.1 Example

In this circuit, we are going to use a 7.5Ω resistor as a shunt, and calculate the current using Ohm's law.

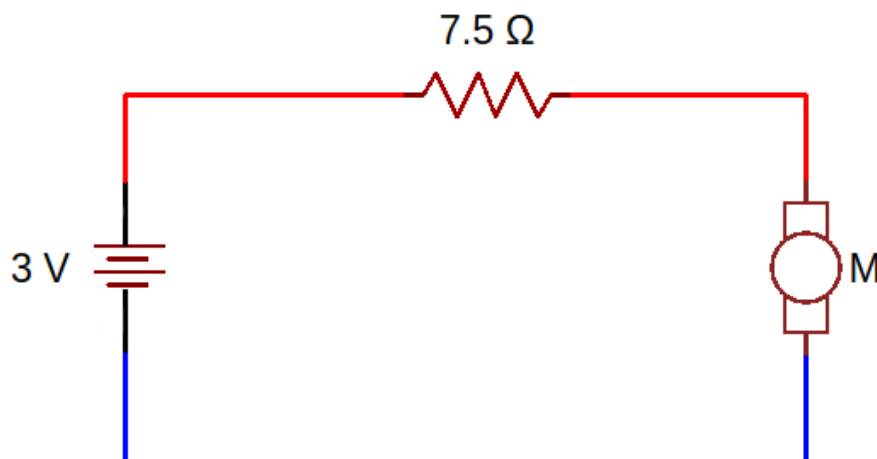

Now, we need to measure the voltage around the 7.5Ω shunt resistor using the multimeter.



The measured voltage in this figure is 1.887 V DC.

Using Ohm's law " $V = I \cdot R$ "

$$1.887 \text{ V} = I \cdot 7.5 \Omega$$

$$I = \frac{1.887 \text{ V}}{7.5 \Omega} = 0.252 \text{ A} = 252 \text{ mA}$$

Now, let us measure the current using the multimeter to compare it with our calculations.



The measured current in this figure is 238 mA.

But there is a tolerance for the resistor, let us measure the resistor.



The measured resistance in this figure is 8.2 Ω.

If we calculate it again using Ohm's law " $V = I \cdot R$ "

$$1.887 V = I \cdot 8.2 \Omega$$

$$I = \frac{1.887 V}{8.2 \Omega} = 0.230 A = 230 mA$$

So, we can count on this way to measure the current, 230 mA is near the value 238 mA.

8.5 Choosing the Right Resistor for an LED

To calculate the resistor for an LED, we need to know the forward voltage for the LED, LEDs are different from the resistors, we need to limit the current passing through it because it does not work on Ohm's law.

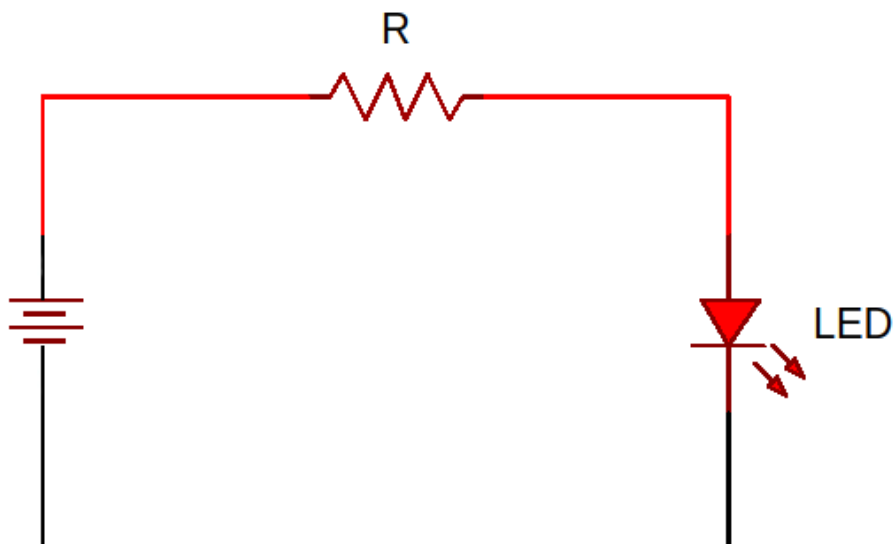

We need to know the voltage around the LED. Usually, a 5 mm LED needs 15 - 30 mA to be in good lighting. After knowing the forward voltage for the LED, it is easy to calculate the resistance.

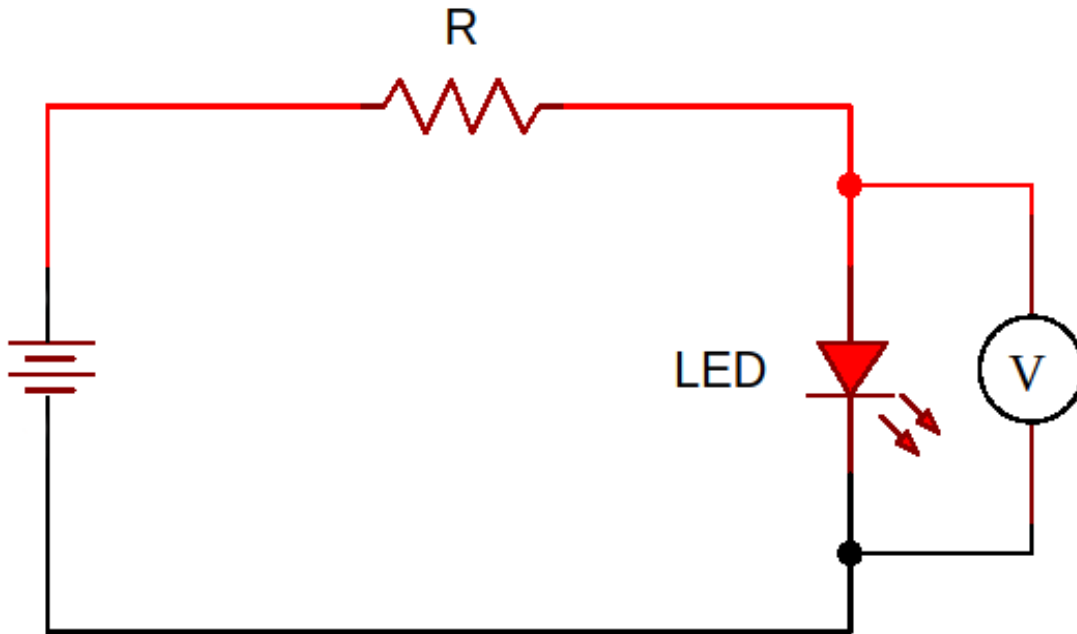

To measure the forward voltage we connect a high value resistor, so we ensure that a low current will pass through the LED.

8.5.1 Example

Calculate the resistance in the following circuit for a red LED to make it consume around 20 mA.

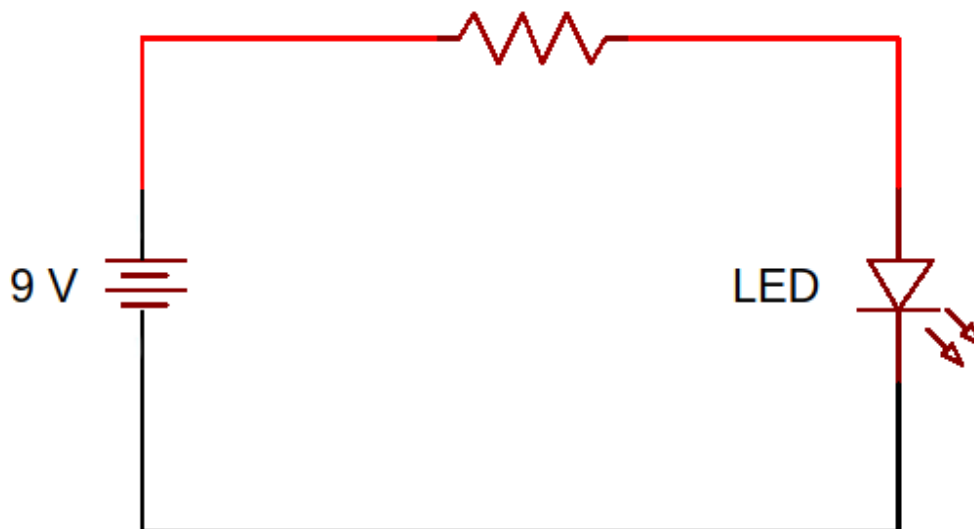

Now, we need to build the circuit with a red LED, and we will use a high resistor, in our case, we will use a **2.2 k Ω** resistor and measure the forward voltage using the multimeter.



The measured voltage in this figure is 1.887 V DC

And if we measure the current in this circuit.



The measured current in this figure is 3.08 mA.

Now, let us calculate the value of the resistor. We have a **9 V** battery, the voltage on the LED is **1.887 V**, so the voltage on the resistor is: $9\text{ V} - 1.887\text{ V} = 7.113\text{ V}$

Now, let us use Ohm's law: $R = \frac{V}{I}$

$$R = \frac{7.113\text{ V}}{20\text{ mA}} = 355.7\ \Omega$$

And the closest standard value is **330 Ω** .

Now, let us build the circuit again using a **330 Ω** resistor and measure the forward voltage again and the current.



The measured voltage in this figure is **2.007 V DC**



The measured current in this figure is **18.78 mA**.

18.78 mA is so close to 20 mA.

8.6 Measuring Internal Resistance of a Battery

We need to follow these steps to measure the internal resistance of a battery using the multimeter. First, we need to measure the voltage of the battery.

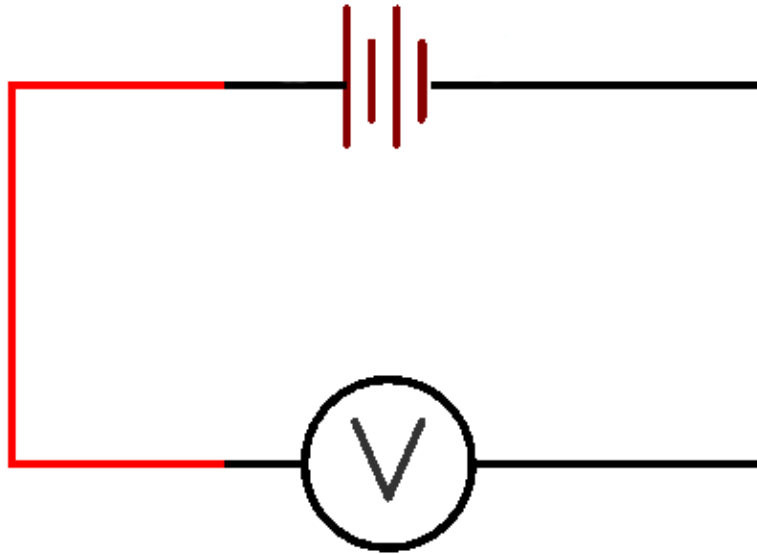

Second, we connect a resistor with the battery and measure its voltage.

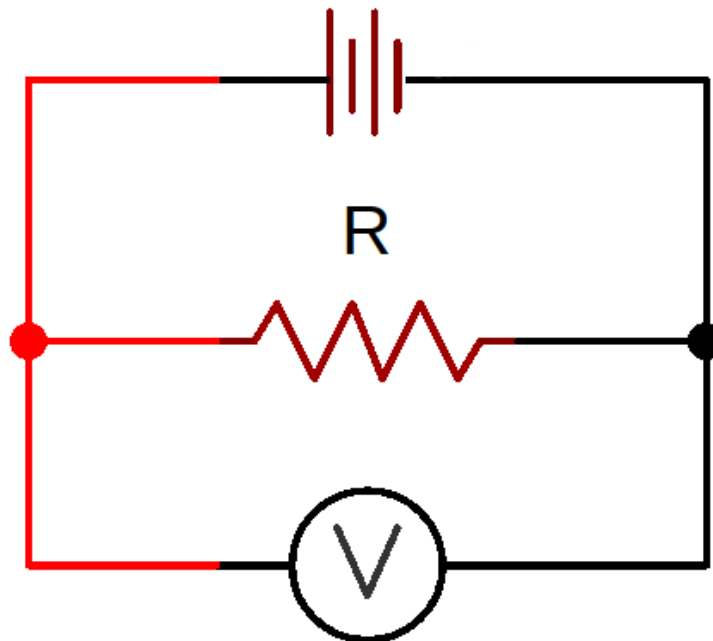

Third, we will do some calculations using Ohm's law.

- Calculate the current passing through the resistor: $\frac{R_V}{R} = I$
- Subtract the voltage of the battery from the voltage on the resistor: $B_V - R_V = B_{RV}$
- Now, we have the current and the voltage on the internal resistance, so we can calculate the value of the internal resistor: $\frac{V}{I} = I_{BR}$

8.6.1 Example

To measure the internal resistance of a 9 V battery, we need to measure the voltage of the battery first.



The measured voltage in this figure is 8.97 V DC.

Second, we connect a resistor with the battery and measure its voltage, in our case we will connect a 510 Ω resistor.



The measured voltage in this figure is 8.59 V DC.

Third, we will do some calculations using Ohm's law.

- Calculate the current passing through the resistor: $\frac{R_V}{R} = I$

$$\frac{8.59V}{510\Omega} = 0.0168 A = 16.8 mA$$

- Subtract the voltage of the battery from the voltage of the resistor: $B_V - R_V = B_{RV}$

$$8.97 V - 8.59 V = 0.38 V$$

- Now, we have the current and the voltage on the internal resistance, so we can calculate the value of the internal resistor: $\frac{V}{I} = I_{BR}$

$$\frac{0.38 V}{0.0168 A} = 22.62 \Omega$$

8.7 Testing Some Components Using Multimeter

In this section, we are going to test some components using a multimeter.

8.7.1 Potentiometer Test

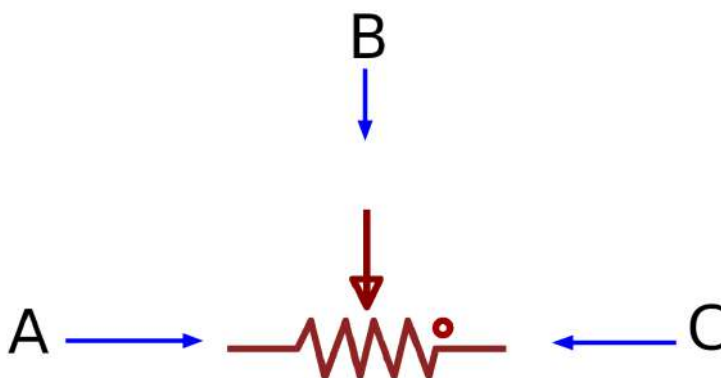

First, we need to measure the resistance between A - C.



And then we measure the resistance between A - B and B - C, the sum of the two values must be equal to A - C.



The measured resistance in this figure is 10.63 kΩ.



The measured resistance in this figure is 40.82 kΩ.

$$10.63 \text{ k}\Omega + 40.82 \text{ k}\Omega = 51.45 \text{ k}\Omega, \text{ which is almost equal to } 50.82 \text{ k}\Omega$$

8.7.2 BJT Transistor Test

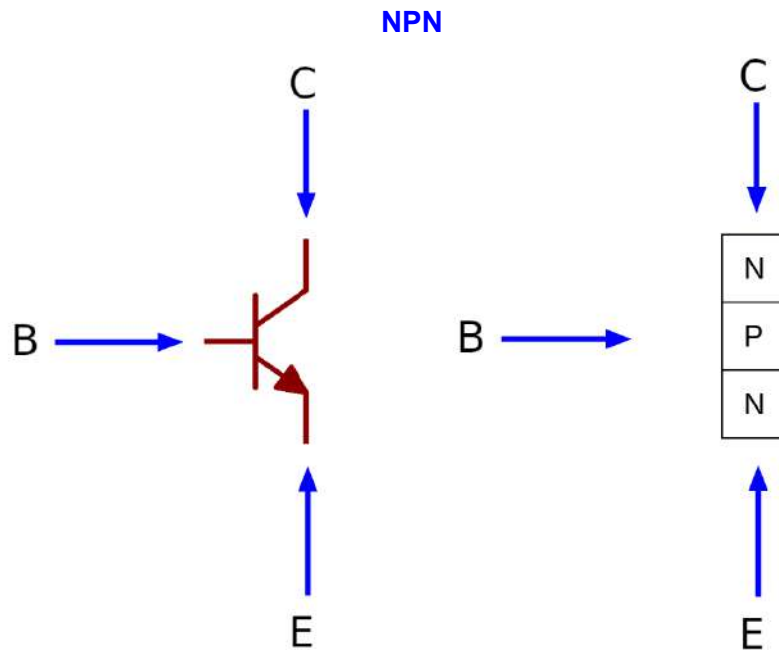

The NPN Type consists of two N-Regions separated by a P-Region, so we can suppose a diode between B - C and between B - E.

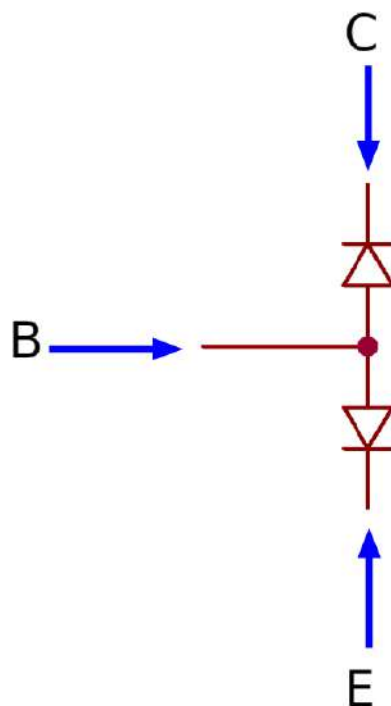

Now, we can test the NPN transistor as 2 diodes. To test the first diode (B - C), we need to connect the red probe to the anode which is the base of the transistor and connect the black probe to the cathode which is the collector of the transistor.



The measured forward voltage is 0.645 V.

To test the second diode (B - E), we need to connect the red probe to the anode which is the base of the transistor and connect the black probe to the cathode which is the emitter of the transistor.



The measured forward voltage in this figure is 0.647 V.

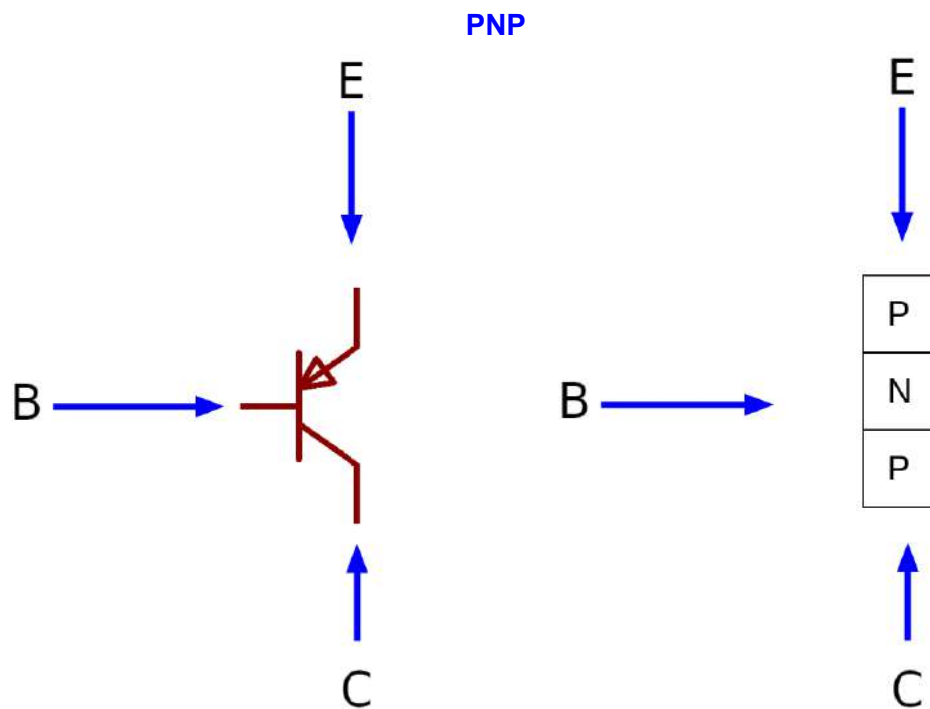

The PNP type consists of two P-Regions separated by N-Region, so we can suppose a diode between B - C and between B - E.

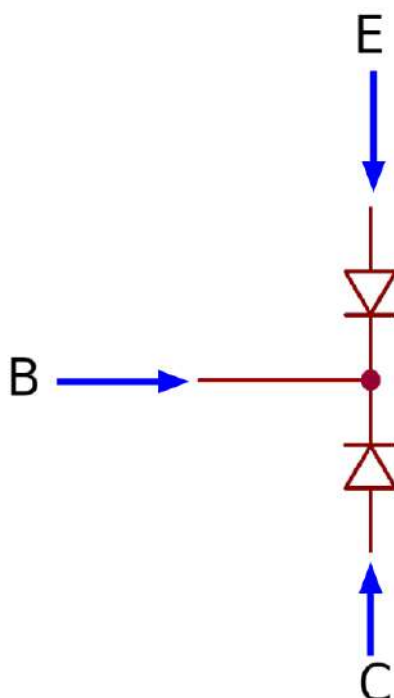

Now, we can test the PNP transistor as 2 diodes. To test the first diode (B - E), we need to connect the black probe to the cathode which is the base of the transistor and connect the red probe to the anode which is the emitter of the transistor.







The measured forward voltage is 0.644 V.





To test the second diode (B - C), we need to connect the black probe to the cathode which is the base of the transistor and connect the red probe to the anode which is the collector of the transistor.



The measured forward voltage in this figure is 0.647 V.





PLUSIVO KITS MULTIMETER AND CLAMP METER KITS

Digital Multimeter Kit	Digital Multimeter Kit with Enhanced Bonus	DM301B Digital Multimeter Kit with Enhanced Bonus	DM401B Digital Multimeter Kit with Enhanced Bonus	DM501D Digital Multimeter Kit with Enhanced Bonus
				

AC Current Clamp Meter	AC/DC Clamp Meter	Digital Clamp Meter 1999 Counts	Digital Clamp Meter 3999 Counts
			

SOLDERING KITS and SOLDERING KITS ACCESSORIES*

Soldering Kit Model 0	Soldering Kit Model 1	Soldering Kit Model 2	Soldering Kit Model 3
			

Soldering Kit Model 4	Soldering Kit Model 5	Solder Wire and Paste Kit*	12 pcs Soldering Tips Kit
		 <p>*Available in different solder weight (50g, 100g) and diameter (0.6mm, 0.8mm, 1mm)</p>	

WIRE KITS

6 spools of different colors





Stranded Silicone Coated Wires	Gauge/No. of Strands	Length
	18 AWG / 150 strands	5 meters each color
	20 AWG / 100 strands	7 meters each color
	22 AWG / 60 strands	7 meters each color
	24 AWG / 40 strands	9 meters each color
	30 AWG / 11 strands	20 meters each color

Solid PVC Coated Wires	Gauge/No. of Strands	Length
	18 AWG	5 meters each color
	20 AWG	7 meters each color
	22 AWG	10 meters each color
	24 AWG	11 meters each color





B. 2 colors (Red and Black)

12 Gauge Silicone Wire Kit	Length / Number of Strands
	3 m each color / 680 strands
	8 m each color / 680 strands





KITS FOR LEARNING ELECTRONICS

Nano Super Starter Kit	Wireless Super Starter Kit with ESP8266	Microcontroller Super Starter Kit	Electronics Component Starter Kit
			

LED KITS

3mm and 5mm LED Kit (310 pcs)	5 mm Diffused LED Kits (600 pcs)	3 mm Diffused LED Kits (1000 pcs)	3 mm Clear Lens LED Kits (1000 pcs)
			

OTHER PLUSIVO KITS

Resistor Kit	Transistor Kit	Dupont Connector Kit	Potentiometer Kit
			

To know more about us and our products, please visit us in our official pages:

www.plusivo.com

<https://www.facebook.com/plusivo/>

For inquiries and assistance about distributorship, please reach us via email address:

office@plusivo.com