

Description

The XLH is an HCMOS Crystal Oscillator with 750fs typical phase jitter over 12kHz to 20 MHz bandwidth. Available in a wide frequency range from 0.750MHz to 250MHz, the IDT XLH Series Crystal Oscillator utilizes a family of proprietary ASICs, with a key focus on noise reduction technologies.

The 3rd order Delta Sigma Modulator reduces noise to the levels that are comparable to traditional Bulk Quartz and SAW oscillators. With short lead-time, low cost, low noise, wide frequency range, excellent ambient performance, the XLH is an excellent choice over the conventional technologies. The XLH has stabilities as tight as ± 20 ppm with extremely quick delivery for both standard and custom frequencies

Features

- Frequency range: 0.750 to 250MHz
- Output Type: HCMOS/LVCMOS Compatible
- Frequency Stability: ± 20 ppm, ± 25 ppm, ± 50 ppm, or ± 100 ppm
- Supply Voltage: 2.5V or 3.3V
- Phase Jitter (1.875MHz to 20MHz): 225fs typical
- Phase Jitter (12kHz to 20MHz): 750fs typical
- Package options: 3.2mm x 2.5mm x 1.0mm (JX4)
5.0mm x 3.2mm x 1.2mm (JS4)
7.0mm x 5.0mm x 1.3mm (JU4)
- Operating Temperatures: -20°C to +70°C or -40°C to +85°C

Pin Assignment

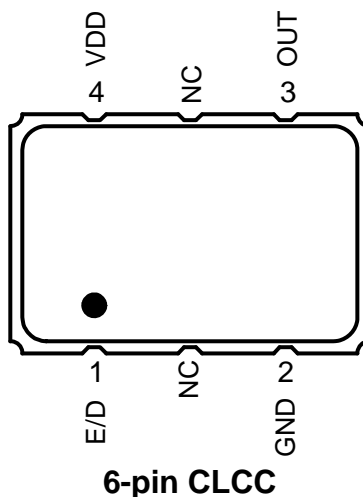

Pin Descriptions

Pin Number	Pin Name	Description
1	E/D	Enable/Disable ¹ (0=Output Disabled)
2	GND	Connect to ground
3	OUT	Output
4	VDD	Supply voltage

1. Pulled high internally.

Absolute Maximum Ratings

Stresses above the ratings listed below can cause permanent damage to the XLH. These ratings, which are standard values for IDT commercially rated parts, are stress ratings only. Functional operation of the device at these or any other conditions above those indicated in the operational sections of the specifications is not implied. Exposure to absolute maximum rating conditions for extended periods can affect product reliability. Electrical parameters are guaranteed only over the recommended operating temperature range.

Item	Rating
VDD	-0.5 to +5.0V
E/D	-0.5 V to VDD + 0.5V
OUT	-0.5 V to VDD + 0.5
Storage Temperature	-55°C to 125°C
Theta Ja (Junction to Ambient)	102°C/W – Still Air

ESD Compliance

Human Body Model (HBM)	1000V
Machine Model (MM)	150V

Mechanical Testing

Parameter	Test Method
Mechanical Shock	Drop from 75cm to hardwood surface–3 times
Mechanical Vibration	10~55Hz, 1.5mm amplitude, 1 minute sweep 2 hours each in 3 directions (X, Y, Z)
High Temperature Burn-in	Under power at 125°C for 2000 hours
Hermetic Seal	He pressure: 4 ±1kgf/cm ² 2 hour soak

Solder Reflow Profile

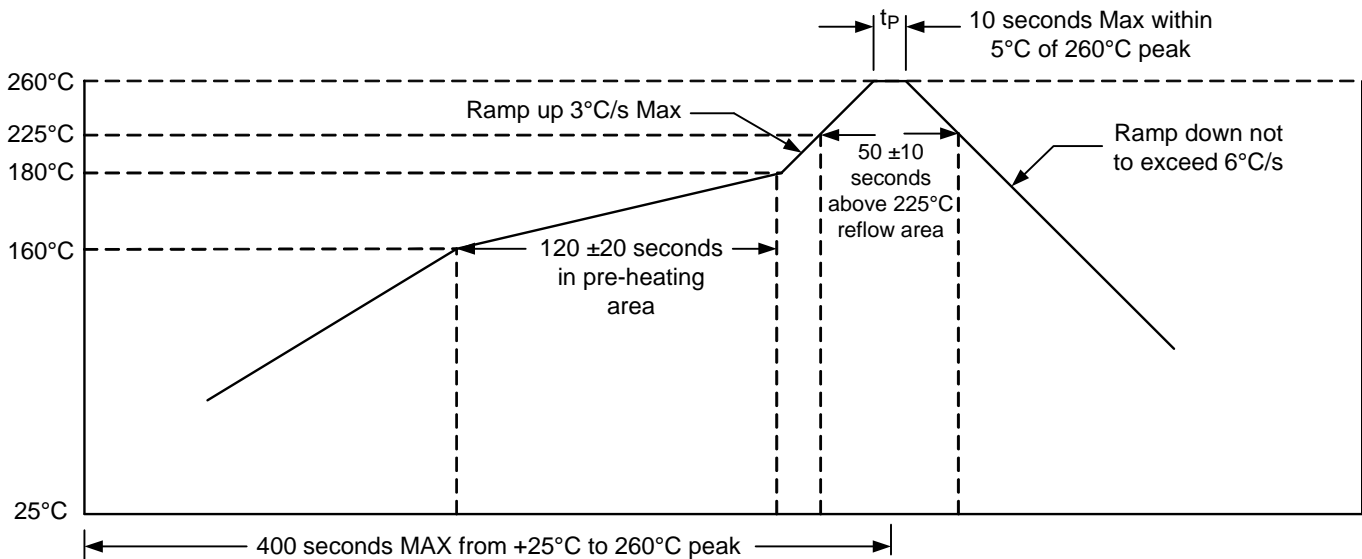

DC Characteristics

($V_{DD} = 3.3V \pm 5\%$, $T_A = -20^\circ C$ to $+70^\circ C$; -40° to $+85^\circ C$)

Parameter	Symbol	Condition	Min	Typ	Max	Units
Power Supply Current	I_{DD}	Standard Frequencies			55	mA
Output HIGH Voltage	V_{OH}	$F_{out} = 0.750$ to $150MHz$ $F_{out} = 150+$ to $250MHz$	$90\%V_{DD}$ $80\%V_{DD}$			V
Output LOW Voltage	V_{OL}	$F_{out} = 0.750$ to $150MHz$ $F_{out} = 150+$ to $250MHz$			$10\%V_{DD}$ $20\%V_{DD}$	V
Enable/Disable Input HIGH Voltage (Output enabled)*	V_{IH}		$70\%V_{DD}$			V
Enable/Disable Input LOW Voltage (Output disabled)	V_{IL}				$30\%V_{DD}$	V

* A pullup resistor from pin 4 (VDD) to pin 1 (E/D) enables output when pin 1 is left open.

AC Characteristics

($V_{DD} = 3.3V \pm 5\%$, $T_A = -20^\circ C$ to $+70^\circ C$; -40° to $+85^\circ C$)

Parameter	Symbol	Condition	Min	Typ	Max	Units
Output Frequency Range	F_{OUTR}		0.750		250	MHz
Frequency Stability		Temperature = $-20^\circ C$ to $+70^\circ C$	± 20		± 100	ppm
		Temperature = $-40^\circ C$ to $+85^\circ C$	± 25		± 100	ppm
Aging (1 st year)		$T_a = 25^\circ C$			± 3	
Aging (10 years)		$T_a = 25^\circ C$			± 10	
Output Load					15	pF
Start-up Time	T_{ST}	Output valid time after VDD meets minimum specified level			10	ms
Output Rise Time		20% to 80% V_{DD}			3	ns
Output Fall Time		80% to 20% V_{DD}			3	ns
Duty Cycle	T_{DTCY}	At 50% V_{DD}	45		55	%
Output Enable/ Disable Time	T_{OE}				100	ns
Period Jitter, RMS	J_{PER}	Frequency = 125MHz		3		psec
Random Jitter	R_J	Frequency = 125MHz Per MJSQ spec (Methodologies for Jitter and Signal Quality specifications)		1.2		psec
Deterministic Jitter	D_J			8		psec
Total Jitter	T_J			25.2		psec
Phase Jitter (12kHz – 20MHz)	ϕ_{JITTER}	Frequency = 125MHz		0.75		psec
Phase Noise Performance Frequency = 125MHz	ϕ_{NOISE}	100Hz of Carrier		-95		dBc/Hz
		1kHz of Carrier		-118		dBc/Hz
		10kHz of Carrier		-120		dBc/Hz
		100kHz of Carrier		-124		dBc/Hz
		1MHz of Carrier		-143		dBc/Hz
		10MHz of Carrier		-153		dBc/Hz
Output Frequency (Standards)	F_{OUT}	10MHz, 12MHz, 12.288MHz, 16MHz, 20MHz, 24MHz, 24.576MHz, 25MHz, 33.333MHz, 40MHz, 48MHz, 50MHz, 100MHz, 125MHz, 156.25MHz (Contact IDT for additional frequencies)				

Note: Inclusive of initial frequency accuracy, operating temperature range, supply variation, load variation, 3 times solder reflow, shock, vibration and 1 year aging at 25°C. We do not recommend hand soldering the devices

DC Characteristics

($V_{DD} = 2.5V \pm 5\%$, $T_A = -20^\circ C$ to $+70^\circ C$; -40° to $+85^\circ C$)

Parameter	Symbol	Condition	Min	Typ	Max	Units
Power Supply Current	I_{DD}	Standard Frequencies			35	mA
Output HIGH Voltage	V_{OH}	$F_{out} = 0.750$ to 160 MHz $F_{out} = 160+$ to 180 MHz	$10\%V_{DD}$ $20\%V_{DD}$			V
Output LOW Voltage	V_{OL}	$F_{out} = 0.750$ to 160 MHz $F_{out} = 160+$ to 180 MHz			$10\%V_{DD}$ $20\%V_{DD}$	V
Enable/Disable Input HIGH Voltage (Output enabled)*	V_{IH}		$70\%V_{DD}$			V
Enable/Disable Input LOW Voltage (Output disabled)	V_{IL}				$30\%V_{DD}$	V

* A pullup resistor from pin 4 (VDD) to pin 1 (E/D) enables output when pin 1 is left open.

AC Characteristics

($V_{DD} = 2.5V \pm 5\%$, $T_A = -20^\circ C$ to $+70^\circ C$; -40° to $+85^\circ C$)

Parameter	Symbol	Condition	Min	Typ	Max	Units
Output Frequency Range	F_{OUTR}		0.750		180	MHz
Frequency Stability		Temperature = $-20^\circ C$ to $+70^\circ C$	± 20		± 100	ppm
		Temperature = $-40^\circ C$ to $+85^\circ C$	± 25		± 100	ppm
Output Load					15	pF
Start-up Time	T_{ST}	Output valid time after VDD meets minimum specified level			10	ms
Output Rise Time		20% to 80% V_{DD}			3	ns
Output Fall Time		80% to 20% V_{DD}			3	ns
Duty Cycle	T_{DTCY}	At 50% V_{DD}	45		55	%
Output Enable/ Disable Time	T_{OE}				100	ns
Period Jitter, RMS	J_{PER}	Frequency = 125MHz		3.3		psec
Random Jitter	R_J	Frequency = 125MHz		1.3		psec
Deterministic Jitter	D_J	Per MJSQ spec (Methodologies for Jitter and Signal Quality specifications)		6.7		psec
Total Jitter	T_J			25.6		psec
Phase Jitter (12kHz – 20MHz)	ϕ_{JITTER}	Frequency = 125MHz		0.85		psec
Phase Noise Performance Frequency = 125MHz	ϕ_{NOISE}	100Hz of Carrier		-91		dBc/Hz
		1kHz of Carrier		-107		dBc/Hz
		10kHz of Carrier		-117		dBc/Hz
		100kHz of Carrier		-123		dBc/Hz
		1MHz of Carrier		-140		dBc/Hz
		10MHz of Carrier		-149		dBc/Hz
Output Frequency (Standards)	F_{OUT}	10MHz, 12MHz, 12.288MHz, 16MHz, 20MHz, 24MHz, 24.576MHz, 25MHz, 33.333MHz, 40MHz, 48MHz, 50MHz, 100MHz, 125MHz, 156.25MHz (Contact IDT for additional frequencies)				

Note: Inclusive of initial frequency accuracy, operating temperature range, supply variation, load variation, 3 times solder reflow, shock, vibration and 1 year aging at 25°C. We do not recommend hand soldering the devices

Output Waveform

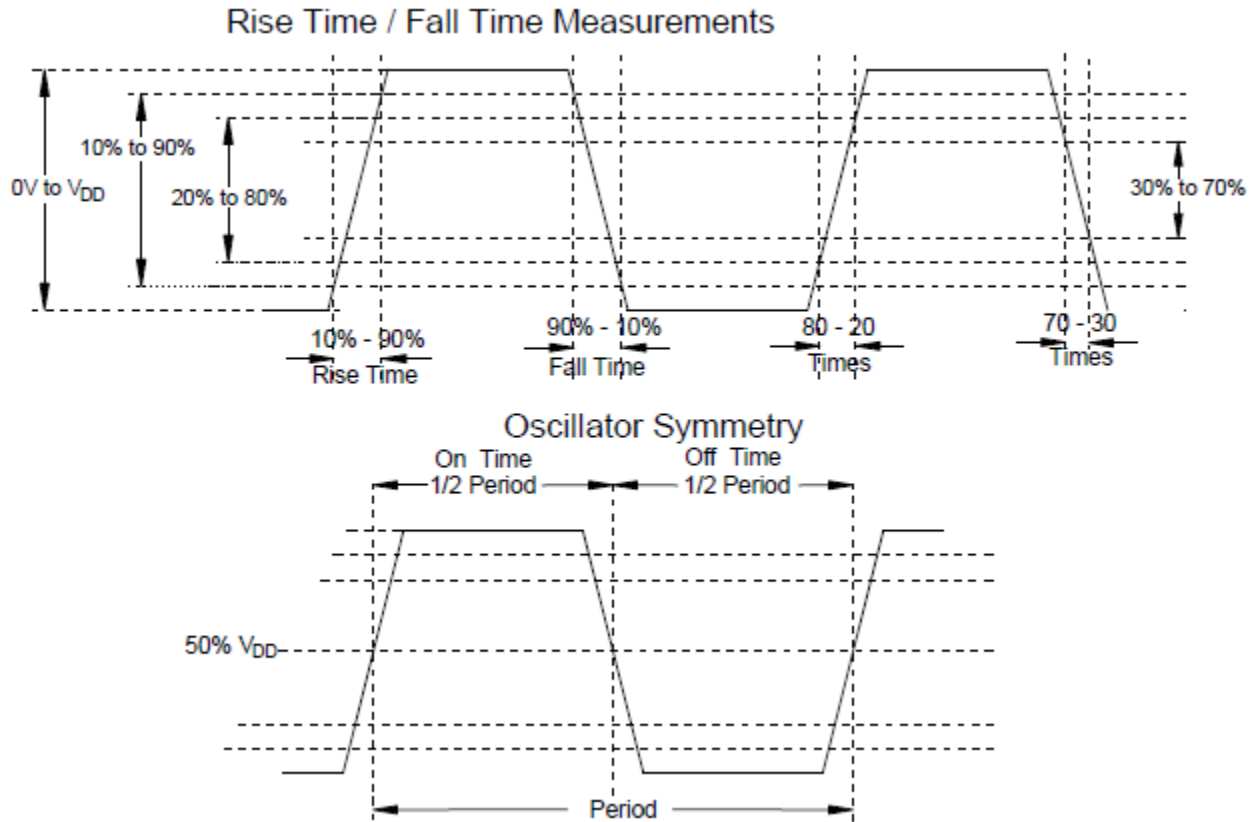

Typical Phase Noise (3.3V)

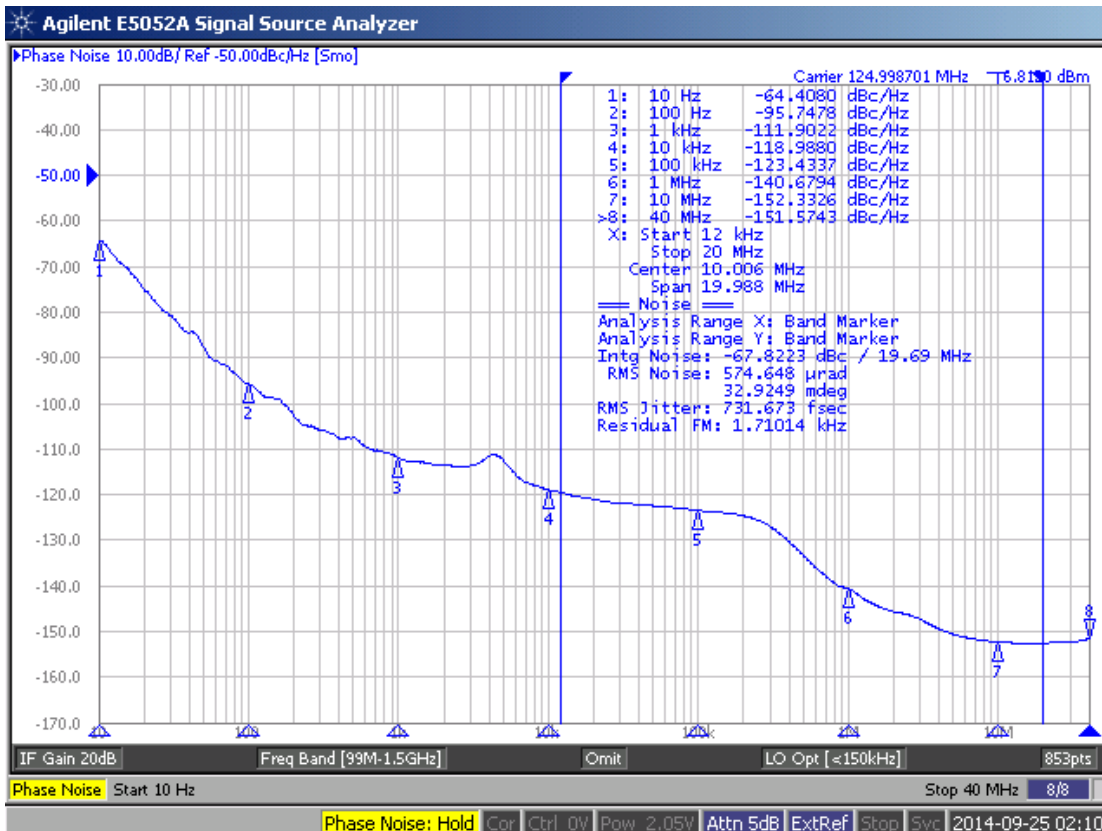

JS4 Package Outline and Dimensions

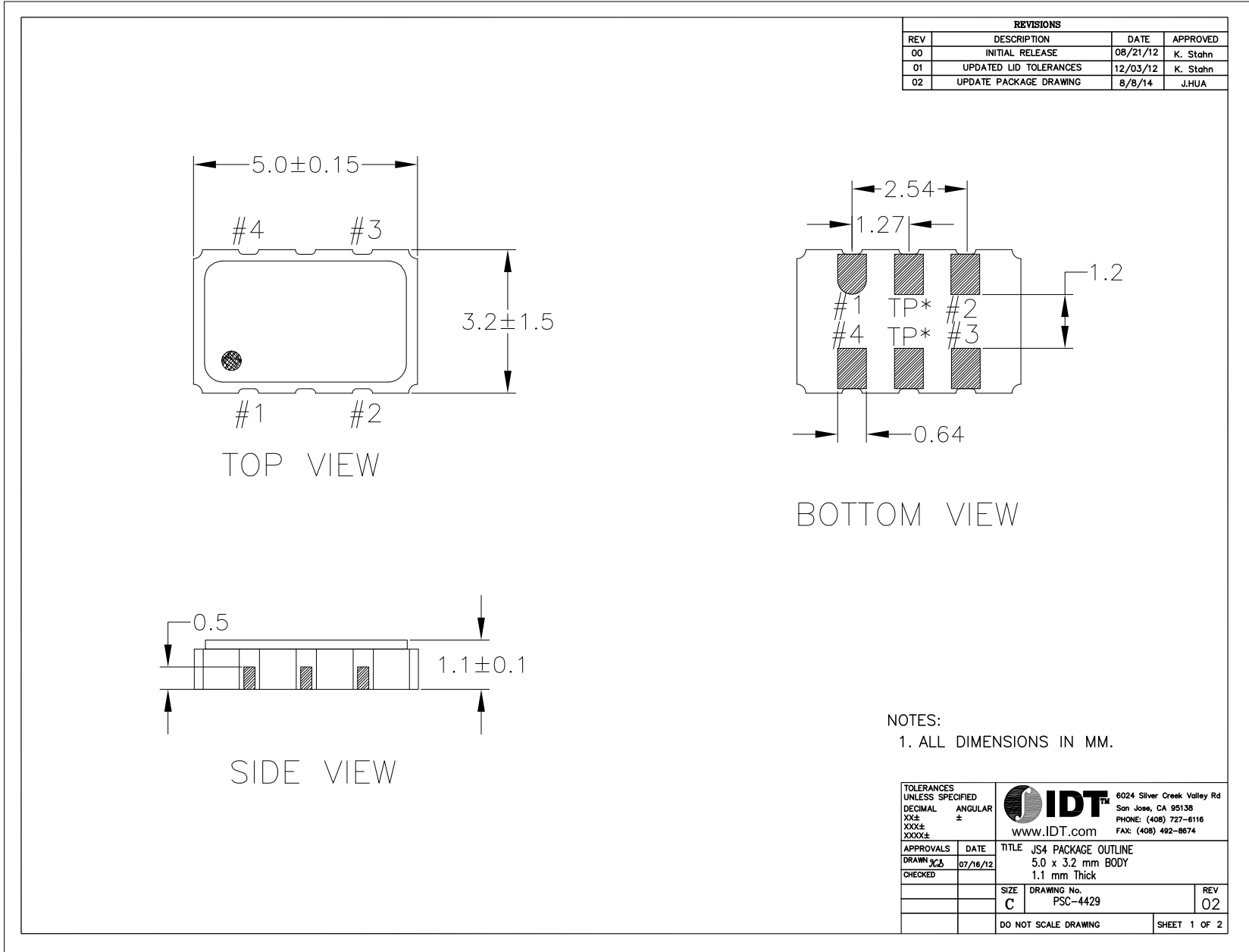

JS4 Package Outline and Dimensions (cont.)

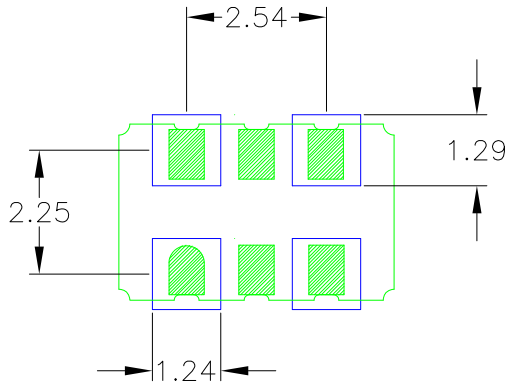

RECOMMENDED LAND PATTERN

NOTES:

1. ALL DIMENSION ARE IN mm. ANGLES IN DEGREES.
2. TOP DOWN VIEW. AS VIEWED ON PCB.
3. COMPONENT OUTLINE SHOW FOR REFERENCE IN GREEN.
4. LAND PATTERN IN BLUE. NSMD PATTERN ASSUMED.
5. LAND PATTERN RECOMMENDATION PER IPC-7351B GENERIC REQUIREMENT FOR SURFACE MOUNT DESIGN AND LAND PATTERN.

REVISIONS			
REV	DESCRIPTION	DATE	APPROVED
00	INITIAL RELEASE	08/21/12	K. Stahn
01	UPDATED LID TOLERANCES	12/03/12	K. Stahn
02	UPDATE PACKAGE DRAWING	8/8/14	J.HUA

TOLERANCES UNLESS SPECIFIED DECIMAL ANGULAR XXX± ± XXXX± XXXX±		6024 Silver Creek Valley Rd San Jose, CA 95138 PHONE: (408) 727-8116 FAX: (408) 492-8674 www.IDT.com
APPROVALS DATE DRAWN: XCS 07/16/12 CHECKED:	TITLE JS4 PACKAGE OUTLINE 5.0 x 3.2 mm BODY 1.1 mm Thick	
SIZE	DRAWING No.	REV
C	PSC-4429	02
DO NOT SCALE DRAWING		SHEET 2 OF 2

JU4 Package Outline and Dimensions

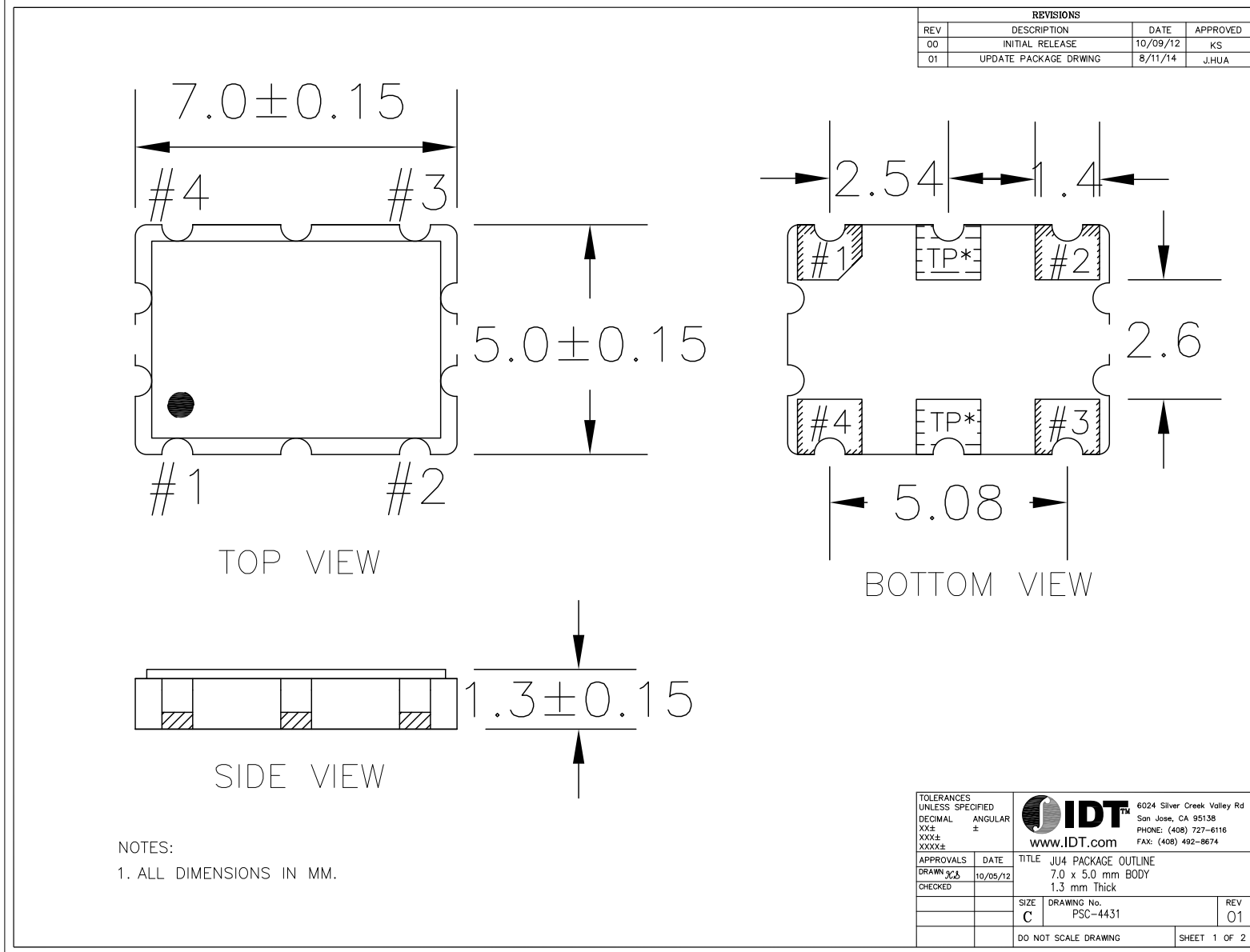

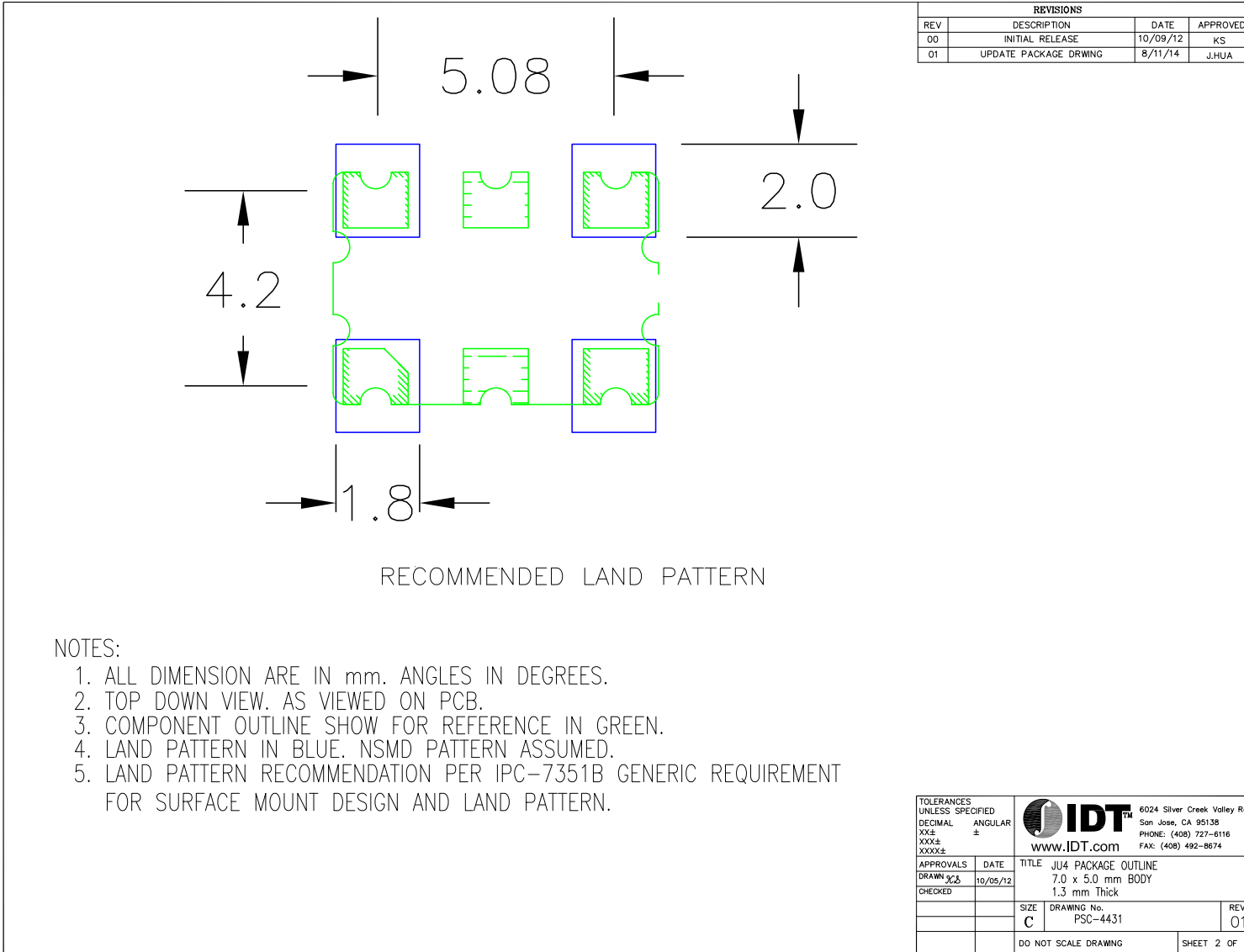

NOTES:

1. ALL DIMENSION ARE IN mm. ANGLES IN DEGREES.
2. TOP DOWN VIEW, AS VIEWED ON PCB.
3. COMPONENT OUTLINE SHOW FOR REFERENCE IN GREEN.
4. LAND PATTERN IN BLUE. NSMD PATTERN ASSUMED.
5. LAND PATTERN RECOMMENDATION PER IPC-7351B GENERIC REQUIREMENT FOR SURFACE MOUNT DESIGN AND LAND PATTERN.

REVISIONS			
REV	DESCRIPTION	DATE	APPROVED
00	INITIAL RELEASE	10/09/12	KS
01	UPDATE PACKAGE DRAWING	8/11/14	J.HUA

<small>TOLERANCES UNLESS SPECIFIED</small> <small>DECIMAL ANGULAR</small> <small>XXX± ±</small> <small>XXXX±</small> <small>XXXX±</small>				<small>6024 Silver Creek Valley Rd</small> <small>San Jose, CA 95138</small> <small>PHONE: (408) 727-6116</small> <small>FAX: (408) 492-8674</small>	
<small>APPROVALS</small> <small>DRAWN</small>		<small>DATE</small> 10/05/12	<small>TITLE</small> JU4 PACKAGE OUTLINE 7.0 x 5.0 mm BODY 1.3 mm Thick		
<small>CHECKED</small>		<small>SIZE</small> C	<small>DRAWING No.</small> PSC-4431	<small>REV</small> 01	
<small>DO NOT SCALE DRAWING</small>				<small>SHEET 2 OF 2</small>	

JX4 Package Outline and Dimensions

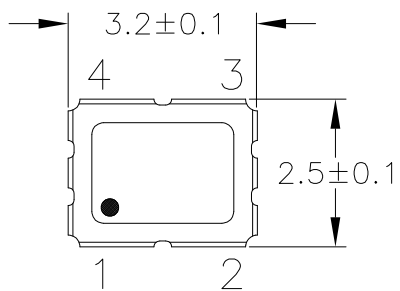

TOP VIEW

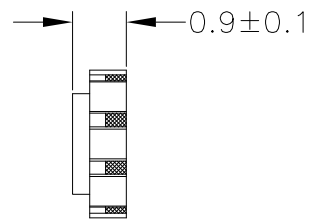

END VIEW

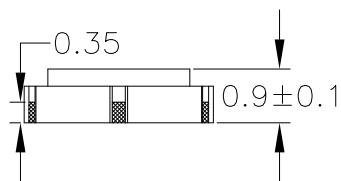

SIDE VIEW

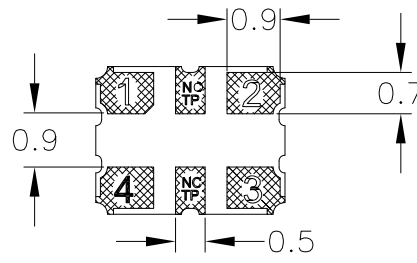

BOTTOM VIEW

REVISIONS			
REV	DESCRIPTION	DATE	APPROVED
00	INITIAL RELEASE	8/8/14	J.HUA

NOTES:

- ALL DIMENSIONS IN MM.

TOLERANCES UNLESS SPECIFIED DECIMAL ANGULAR XX± ± XXX± XXXX±		6024 Silver Creek Valley Rd San Jose, CA 95138 PHONE: (408) 727-6116 FAX: (408) 492-8674 www.IDT.com
APPROVALS DRAWN <i>RAC</i> CHECKED	DATE 8/8/14	
TITLE JX4 PACKAGE OUTLINE 3.2 x 2.5 mm BODY 0.9 mm Thick		
SIZE C	DRAWING No. PSC-4489	REV 00
DO NOT SCALE DRAWING		SHEET 1 OF 2

JX4 Package Outline and Dimensions (cont.)

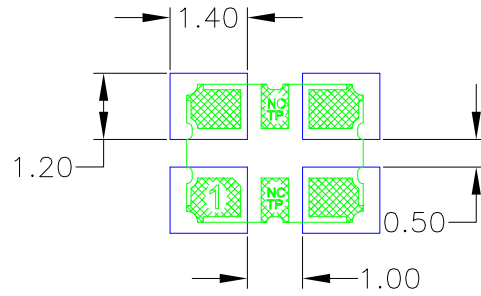

RECOMMENDED LAND PATTERN

NOTES:

1. ALL DIMENSION ARE IN mm. ANGLES IN DEGREES.
2. TOP DOWN VIEW. AS VIEWED ON PCB.
3. COMPONENT OUTLINE SHOW FOR REFERENCE IN GREEN.
4. LAND PATTERN IN BLUE. NSMD PATTERN ASSUMED.
5. LAND PATTERN RECOMMENDATION PER IPC-7351B GENERIC REQUIREMENT FOR SURFACE MOUNT DESIGN AND LAND PATTERN.

REVISIONS			
REV	DESCRIPTION	DATE	APPROVED
00	INITIAL RELEASE	8/8/14	J.HUA

TOLERANCES UNLESS SPECIFIED		6024 Silver Creek Valley Rd San Jose, CA 95138 PHONE: (408) 727-6116 FAX: (408) 492-8674 www.IDT.com
DECIMAL	ANGULAR	
XX±	±	
XXX±		
APPROVALS		TITLE
DRAWN <i>BAC</i>	DATE 8/8/14	JX4 PACKAGE OUTLINE
CHECKED		3.2 x 2.5 mm BODY
		0.9 mm Thick
SIZE	DRAWING No.	REV
C	PSC-4489	00
DO NOT SCALE DRAWING		SHEET 2 OF 2

IDT Ordering Information

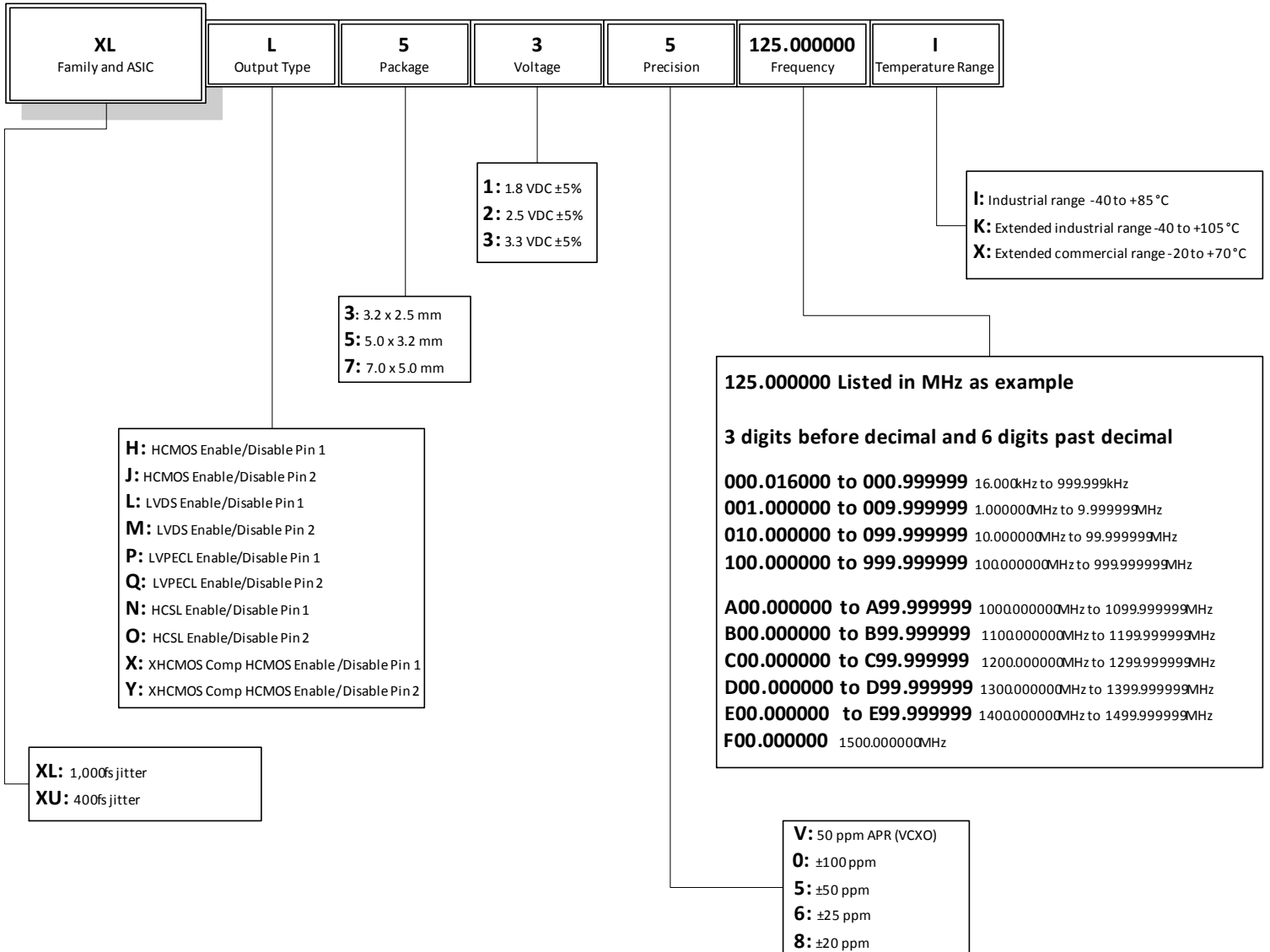

Revision History

Date	Originator	Description of Change
10/01/14	B. Chandhoke	1. Corrected typo in spec for Enable/Disable Low Voltage; from $\geq 30\%VDD$ to $\leq 30\%VDD$. 2. Moved from Advance to Preliminary.
12/10/14	B. Chandhoke	1. Added 7 x 5 x 1.3mm JU4 and 3.2 x 2.5 x 1.0mm JX4 package options and package dimension/landing pattern drawings. 2. Updated ordering information table/graphic to show added package options.
10/28/16	P. Jenkins	Update ordering information decoder tables by separating them into Scheme 1 and Scheme 2; add note to distinguish the two tables.
06/13/17	L.S.	Removed "Ordering Information Scheme #1 (for reference only)". Replaced with a single ordering information table.
06/20/17	L.S.	Corrected frequency errors in Ordering Information table.



Corporate Headquarters
6024 Silver Creek Valley Road
San Jose, CA 95138 USA
www.IDT.com

Sales
1-800-345-7015 or 408-284-8200
Fax: 408-284-2775
www.IDT.com/go/sales

Tech Support
www.idt.com/go/support

DISCLAIMER Integrated Device Technology, Inc. (IDT) and its affiliated companies (herein referred to as "IDT") reserve the right to modify the products and/or specifications described herein at any time, without notice, at IDT's sole discretion. Performance specifications and operating parameters of the described products are determined in an independent state and are not guaranteed to perform the same way when installed in customer products. The information contained herein is provided without representation or warranty of any kind, whether express or implied, including, but not limited to, the suitability of IDT's products for any particular purpose, an implied warranty of merchantability, or non-infringement of the intellectual property rights of others. This document is presented only as a guide and does not convey any license under intellectual property rights of IDT or any third parties.

IDT's products are not intended for use in applications involving extreme environmental conditions or in life support systems or similar devices where the failure or malfunction of an IDT product can be reasonably expected to significantly affect the health or safety of users. Anyone using an IDT product in such a manner does so at their own risk, absent an express, written agreement by IDT.

Integrated Device Technology, IDT and the IDT logo are trademarks or registered trademarks of IDT and its subsidiaries in the United States and other countries. Other trademarks used herein are the property of IDT or their respective third party owners. For datasheet type definitions and a glossary of common terms, visit www.idt.com/go/glossary. Integrated Device Technology, Inc.. All rights reserved.