



# ACEBOTT

**Smart Home Starter Kit  
For ESP32**

# Perface

## Our Company

ACEBOTT STEM Education Tech Co.,Ltd

Founded in China's Silicon Valley in 2013, ACEBOTT is a STEM education solution leader. We have a team of 150 individuals, including members from research and development, sales, and logistics. Our goal is to provide high-quality STEM education products and services to our customers. We are working together with STEM education experts and our business partners to produce successful STE products together. Our self-own factory also provides CEM services for our clients including logo customization on product packaging and PCB.

## Our Tutorial

This course and smart home learning kit is designed for 8+ children and teenagers to learn more about ESP32 board and smart home knowledge, sensors and circuit components. If you like to learn ESP32 smart home knowledge, this kit could provide you the knowledge and steps to build your own smart home together with Dr. Lumi.

## Through this kit, you can:

1. Learn how to effectively use the ESP32 board, including uploading code, understanding its features, and coding with the ARDUINO IDE.
2. Gain a solid foundation in the basics of the C language, as the ESP32 utilizes a simplified C/C++ programming language for controlling circuits and sensors.
3. Explore various electronic components such as LEDs, sensors, and motors, and understand how they work together in real-world smart home projects.
4. Enhance your maker skills by building your own smart home using the ACEBOTT kit, following step-by-step tutorials.
5. Implement essential functions like auto response, App control, and voice control in your smart home project.
6. Develop a comprehensive understanding of smart home technology, preparing you for more advanced learning in the future.

In summary, the ACEBOTT smart home learning kit is specifically designed to introduce beginners to the world of ESP32-based smart home development. With this



kit, users can gain a comprehensive understanding of how controller boards and sensors function within the context of a smart home. By following the provided tutorials, individuals of all ages can acquire valuable knowledge about smart home technology and successfully build their own smart home projects.

## **Customer service**

ACEBOTT is a dynamic and fast-growing STEM education technology company that strives to offer excellent products and quality services that meet your expectations. We value your feedback and encourage you to drop us a line at [support@cebott.com](mailto:support@cebott.com) with any comments or suggestions you may have.

Our experienced engineers are dedicated to promptly addressing any problems or questions you may have about our products. We guarantee a response within 24 hours during business days.

# Contents

Lumi's Adventure to Save the Lost City .....	1
Task 1: Repair the street lights to illuminate the yard .....	9
Task 2: Give the street lamp wisdom - Let the street lamp learn to breathe .....	14
Task 3: Save energy! Let's add a switch to control the light .....	18
Task 4: Add eyes to the street lamp .....	22
Task 5: The Secret in the Light .....	25
Task 6: It's dark and someone please light up .....	29
Task 7: Test whether the Shield works properly .....	32
Task 8: The secrets of the Time Mirror Light .....	35
Task 9: It's starting to rain. Come in! .....	40
Task 10: The most important part of the Smart Home .....	45
Task 11: Make the temperature and humidity values visible .....	48
Task 12: The rain has stopped. Start repairing the Gate! .....	52
Task 13: The Guardian's Shield has been launched .....	58
Task 14: Try something new .....	63
Task 15: A magical communication method--WIFI .....	67
Task 16: WIFI can also control doors and windows .....	74
Task 17: A new interactive control .....	78
Task 18: Leave a gift .....	86

## **Lumi's Adventure to Save the Lost City**

In 3023, science and technology are highly developed, and humans have found a special substance on Jupiter and named it "Jupiter II".

Using "Jupiter II", Dr.Lumi has created a "Time Mirror Light ". Just stand in front of this mirror and start the machine to travel in time.

September 29, 3023, is an ordinary day for most people, But that day was the beginning of Dr. Lumi's adventure. On this day, Dr. Lumi, who is trying to build a portable Time Mirror Light. Dr. Lumi is resting on a recliner with his eyes closed. Dr. Lumi's cat slips out of her cage to play, and pats her paw at the glowing start button on the portable time mirror. After a flash of light, Dr. Lumi is sucked into the time mirror, and through a dazzling time tunnel, Dr. Lumi appears on an unknown planet.

Perhaps unaccustomed to the air, Dr. Lumi felt dizzy.

When he woke up, Dr. Lumi found himself in a hospital with equipment that looked decrepit.

When the nurse saw that Dr. Lumi was awake, she excitedly ran out the door. "Mayor Johnny, Dr. Lumi is awake!"

At this time, an old panda with glasses came in. The old man looked at Dr. Lumi and said, "Dr. Lumi, long time no see, I'm Johnny, now the mayor of the lost city, did you come back to save us?"

Dr. Lumi looked at the old man quizzically, but with a sense of familiarity. "Mayor Johnny, we seem to know each other."

The old man looked at Dr. Lumi and said, "Dr. Lumi, when I was young, I went on adventures with you.

Now the situation is urgent. When you were found, a huge meteorite appeared in the sky at the same time. After 24 hours of observation by astronomers, the meteorite will fall and the entire lost city will be destroyed."

Lumi listened in amazement. A meteorite colliding with a planet would destroy all living things in a city.

"Mayor Johnny, is the technology on this planet capable of destroying meteorites ahead of time?"

Mayor Johnny shook his head. "The Lost City has long relied on the shield you built to keep everyone safe.

Three days ago, the Guardian Shield system of the Lumi's Smart Home suddenly failed to activate. We conducted a field check, and it seems that the Lumi's Smart Home has disintegrated. If the Lumi's Smart Home were intact, it would create a shield that

could cover the entire Lost City, easily defending against meteorites."

Dr. Lumi searched his brain for memories. There was no memory of Lumi's Smart Home. "What do I need to do?"

Mayor Johnny says to the door, "Please come in," as you walk in, carrying a Smart Home Kit.

"Dr. Lumi, this warrior will work with you to rebuild the Lumi's Smart Home and restore the shield system."

You stand up and say, "Good morning, Dr. Lumi, I'm going to be your assistant to help you with this work."

Dr. Lumi walked out of the hospital and accompanied by you--the warrior, went to Lumi's Smart Home. Dr. Lumi looked at the sky, eclipsed by the sun, and dark as evening.

"Time travel always brings unexpected experiences," Dr. Lumi thought. "I hope everything goes well."

Dr. Lumi lifted his hand and open the scanner watch and found that the planet's air was almost identical to Earth's, and that the entire planet was a vast steppe, with water from melting snow and ice in the mountains meandering through the land.

However, the current level of science and technology is in the third stage of scientific and technological civilization, mainly using electronic devices to make scientific and technological products.

Not far from the horizon, there is a small hill. On the top of the hill is the location of Lumi's Smart Home.

When the meteorite appeared, the sky was like a display screen, and there was a 24-hour countdown. Dr. Lumi looked up. The red digital clock in the sky was ticking away, like a time limit given in a game.

Dr. Lumi then asked, "Is there anything special about the Lumi's Home?"

After talking, I learned that Lumi's Home uses a smart system, which can communicate by voice, WiFi control and other magical functions. In addition to Dr. Lumi, others temporarily do not have the corresponding knowledge to enter the maintenance. When Lumi's Smart Home returns to normal, the Lost City's protective shield will once again cover the entire Lost city, and the people will be saved from the meteor threat.

Come on Warriors, help Dr. Lumi rebuild the Lumi's Smart Home as soon as possible!

You take Dr. Lumi to the Lumi's Smart Home. Dr. Lumi looks at the broken walls in front of him. Fortunately, the materials used are relatively strong, and the walls are crumbling but not damaged.

Suddenly you spot the neatly arranged wooden boxes in the rubble and ask, "What is this?"



Dr. Lumi takes the wooden box and opens it. After a flash of blue light, Dr. Lumi is instantly informed of all the information of the Lumi's Smart Home. At the same time, the 3D projection device on his arm automatically opens to show the information of the Lumi's Smart Home. Dr. Lumi is surprised to find that the Lumi's Smart Home has a portable Time Mirror Light, and a secret device hidden inside it.



Holding back his excitement, Dr. Lumi switched the screen with his hand and said: Here are the drawings for the Lumi's Smart Home.

Now, help Dr. Lumi rebuild the Lumi's Smart Home, click to get the construction drawings, [Click to get construction drawings,](#)

Follow the wiring to build the Lumi's Smart Home, and then go on the adventure below.

**Note: The connection of the DuPont line should be careful, or it may damage the Lumi's Smart Home.**

After continuous restoration, the Lumi's Smart Home was restored.

"Well," Dr. Lumi says appreciatively, "the facade of the Lumi's Smart Home is restored and the wiring is restored."

You look at the restored Lumi's Home and say, "Is it possible to unlock the Guardian Shield now?"

Dr Lumi shook his head and said: "The repair of the Guardian Shield is a step by step process. The first step is to restore control of the electronic circuit."

If you want the electronic circuit to obey to you, you need a tool that can talk to the electronic circuit - Arduino IDE.

[To install the Arduino IDE on Windows click here](#)

[To install Arduino IDE for Mac OS click here.](#)

The installation of Arduino IDE in the computer is completed.

Because the Arduino IDE software does not have ESP32 controller board, it is impossible to directly use the ESP32 controller board, It's like you have a new toy and you don't know how to play with it and you need instructions.

So you need to add ESP32 information to Arduino IDE, the steps can refer to the following: [Install the ESP32 plugin in the Arduino IDE.](#)

"Great, you've finished installing the software and simply seeing how to find the ESP32 in the software."

"The first step is to choose the right board by following these steps: **Tools > Board > esp32 > ESP32 Dev Module** ."

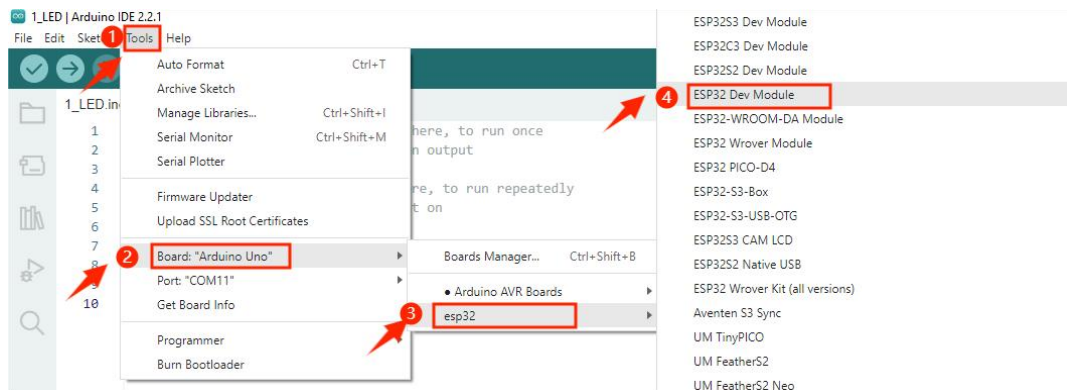

"Step two, follow these steps to select the correct port: **Tools > Port > COM11**(Select the appropriate COM port on your computer)."

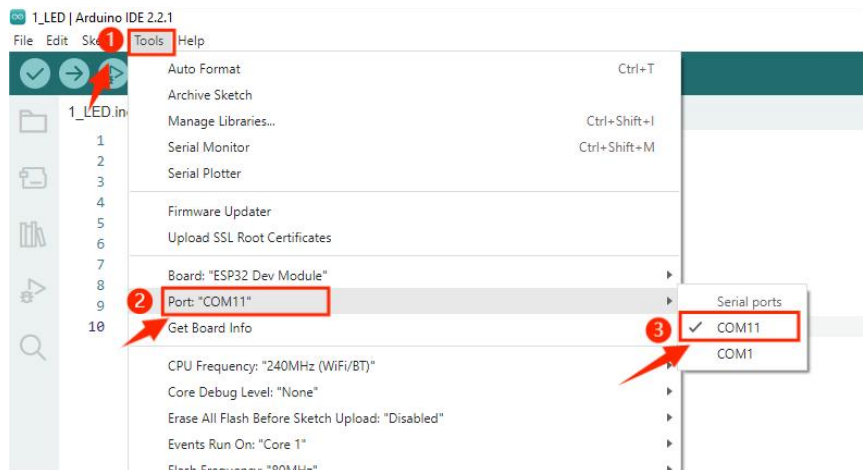

Note: The COM port to connect to is usually not COM1. Click another COM port.

"Let's meet the brain of Lumi's Smart Home, the ESP32 controller board."

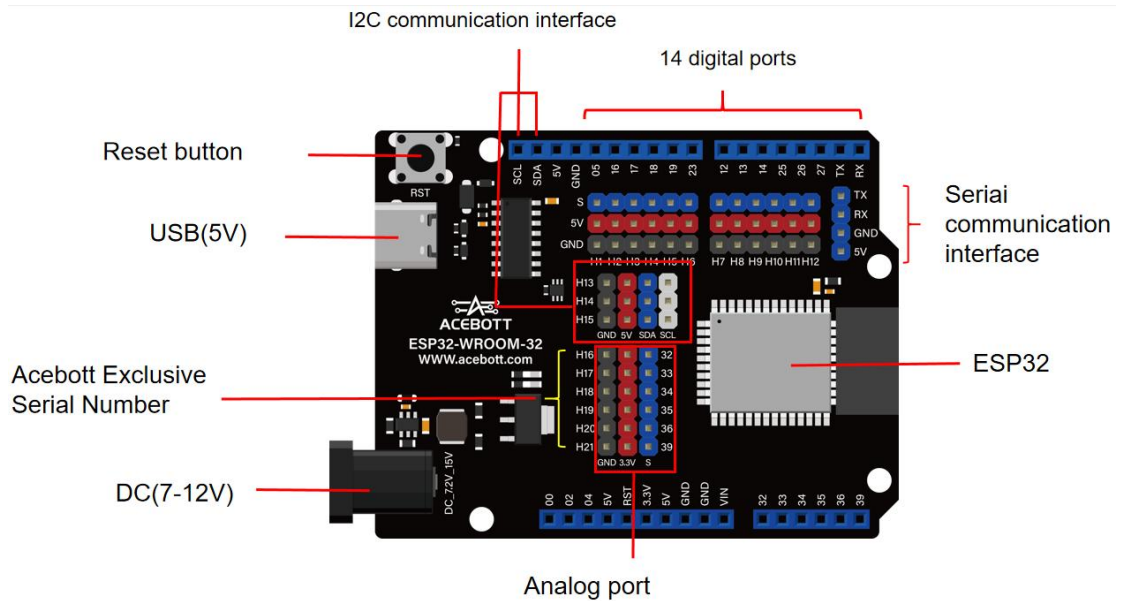

Note: Due to the access of electronic modules, USB may be insufficient power supply, please try to use external power supply (DC).

Dr. Lumi looked up at the sky and could already see the meteorite hanging in the sky, with only 18 hours left before it fell.

Dr. Lumi says to you: "We have to hurry up....."

## THE COUNTDOWN: 18 HOURS

### **Task 1: Repair the street lights to illuminate the yard**

"I will teach you all the knowledge and skills you need to build the Lumi's Smart Home. Then you can guard the Lost City alone."

"Says Dr. Lumi, patting you on the shoulder.

You nod and say, "Okay, Dr. Lumi, where do we start?"

Dr. Lumi said: 'The sky is now darkening as if there was a solar eclipse because of the meteorites. You and Dr. Lumi look up at the sky, thinking.

"We started by lighting up the Lumi hut to see if the energy could be used," says Dr. Lumi.

The doctor pointed to the intact power supply and said, "You see, the power supply only needs to be plugged into any of the following ports."

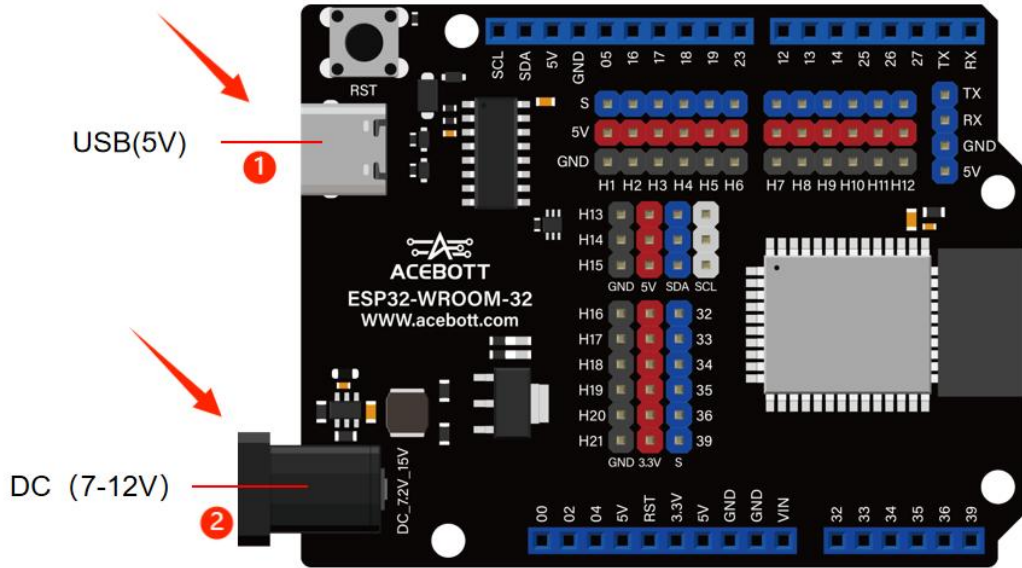

"Dr. Lumi, I know that a power source can provide current and voltage."

"I will introduce current and voltage for you in detail," says Dr. Lumi, pointing to a picture.

### Current and voltage

**Current:** It represents the movement of electrons in a wire or circuit, much like water molecules flowing in a pipe.

**Voltage:** It represents the "driving force" of the current, like the water pressure in the flow of water.

**The direction of the current:** from the positive (high voltage end) of the power supply to the negative (low voltage end) of the power supply, like water flowing from high to low.

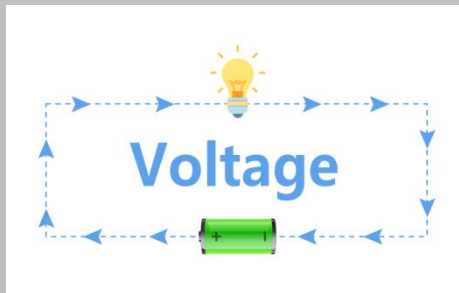

When an electric current flows through a light bulb, it lights up. In the same circuit, when the voltage is higher (higher pressure), the current is higher (faster water flow), the bulb will be brighter.

Then Dr. Lumi pointed to the street lamp and said, "Next, let's learn to light the street lamp together and light up the entire yard."

### LED Module

LED module is a component that integrates LED lamp beads, drive circuits, and shell to provide lighting, indicating, or display functions. According to the specific application requirements, the LED module can be a wide variety of shapes, sizes and colors, and its color depends on the material and the light emitting principle.

A high level output to the LED module means to turn on the LED light, and a low level output to the LED module means to turn off the LED light.

The LED module can also be controlled by analog signals, the larger the input signal value, the brighter the LED light.

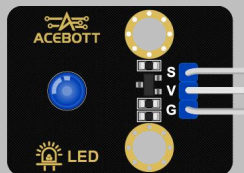

"Dr. Lumi, now that the circuit is connected, how do we power the LED?"

"Next, you need to write commands in the Arduino IDE software to make the wires behave and power up the leds." Dr. Lumi opened the projection screen on his arm and said, "You can

refer to this for instructions."

```
void setup() { // put your setup code here, to run once
  pinMode(5, OUTPUT); // set pin 5 as an output
}
void loop() { // put your main code here, to run repeatedly
  digitalWrite(5, HIGH); // let the light on
  delay(1000); // wait for one second
  digitalWrite(5, LOW); // let the light off
  delay(1000); // wait for one second
}
```

Of course, there's a simple way to open this hyperlink directly to the program: [Click to get the street lamp program.](#)

Remember to confirm the "Board" and "Port", and follow the prompts below to upload the program:



Program upload, when the progress display number to 100%, upload program ends.

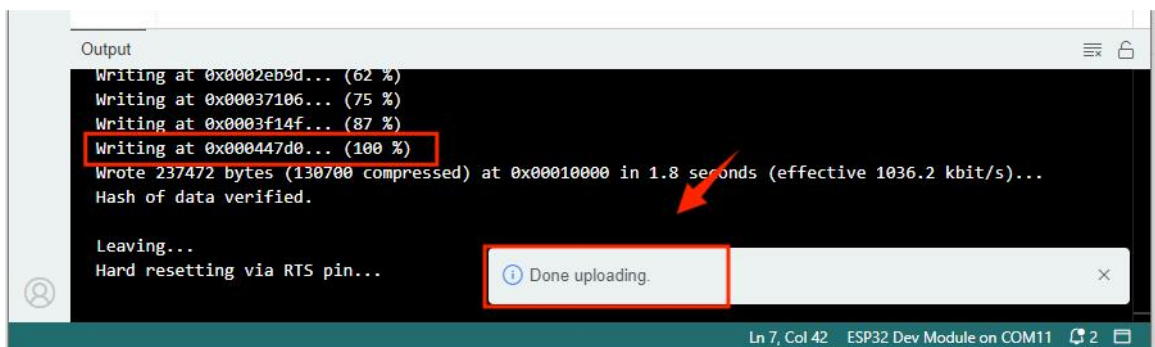

After the program is uploaded, you can press the Reset button on the ESP32 controller board to restart the ESP32 controller board and let the program start running again.



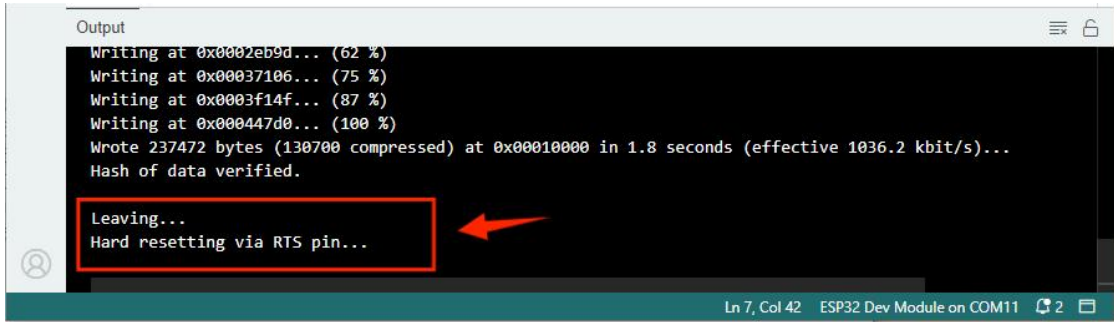

```
Output
Writing at 0x0002eb9d... (62 %)
Writing at 0x00037106... (75 %)
Writing at 0x0003f14f... (87 %)
Writing at 0x000447d0... (100 %)
Wrote 237472 bytes (130700 compressed) at 0x00010000 in 1.8 seconds (effective 1036.2 kbit/s)...
Hash of data verified.

Leaving...
Hard resetting via RTS pin...
```

Ln 7, Col 42 ESP32 Dev Module on COM11

After uploading the program, the following effects will appear:  
the LED module will light up for one second and go off for one second.



"Well done, the street lights are on." You and Dr. Lumi look at the lights and know that you are one step closer to saving the lost city.

## THE COUNTDOWN: 17 HOURS

### **Task 2: Give the street lamp wisdom - Let the street lamp learn to breathe**

Dr. Lumi looks at you and says, "Next, we're going to try to make streetlights smart."

You look at Dr. Lumi with anticipation. "How? Dr. Lumi."

"We can learn to breathe from the human movement, so that the street lamp also learns to breathe."

"How can street lights achieve the effect of breathing?"

"Design a specific breathing rhythm of the light, so that the brightness of the light changes according to a certain frequency. The lighting system can be programmed to set the rhythm and frequency of breathing to achieve the effect of light breathing," said Dr. Lumi, looking at the street lamp.

"How do we do that?"

"To achieve the breathing light effect, the brightness of the LED needs to be gradually increased and decreased over a certain time horizon. This can be achieved by varying the duty cycle of the PWM. For example, in the exhalation phase, the duty cycle decreases gradually and the brightness of the LED decreases

gradually; During the inspiratory phase, the duty cycle is gradually increased and the brightness of the LED is gradually enhanced."

"What is PWM? That sounds complicated." You're scratching your head. Dr. Lumi opens the projection screen to project the relevant knowledge.

#### **PWM**

PWM is the abbreviation for "Pulse Width Modulation" . Use different duty cycle to simulate the "analog output". The duty cycle is the proportion of time in a pulse cycle that is high to the total cycle time, the unit is % (0%-100%).

By changing the duty cycle of the PWM, the average voltage of the output signal can be changed to realize the output of the analog voltage.

PWM can use the statement "analogWrite(pin,dutyCycle)" to implement a PWM with a specified duty cycle, where the value of pin is the pin of the control board and the value of dutyCycle is between 0 and 255, where 0 is the duty cycle 0% and 255 is the duty cycle 100%.

For example, the statement "analogWrite(pin,127) " has a duty cycle of 50%, which means that if you plug in 5V, it is equivalent to only putting in 2.5V.

"Ok, but how do we code?"

"You can refer to this program," Dr. Lumi said, opening a projection screen on his arm.

```
void setup() {  
  pinMode(5, OUTPUT); // set pin 5 as an output  
}  
void loop() {  
  for(int i=0;i<255;i++){ // loop from 0 to 254  
    analogWrite(5,i); // write the value of 'i' to pin 5 (PWM output)  
    delay(5); // delay for 5 milliseconds  
  }  
  for(int i=255;i>0;i--){ // loop from 255 to 1  
    analogWrite(5,i); // write the value of 'i' to pin 5 (PWM output)  
    delay(5); // delay for 5 milliseconds  
  }  
}
```

Of course, I will also provide you with the easiest way to open this hyperlin: [Click to get the breath lamp program.](#)

Remember to confirm the Board and Port, and follow the prompts below to upload the program:



Program upload, when the progress display number to 100%, upload program ends.

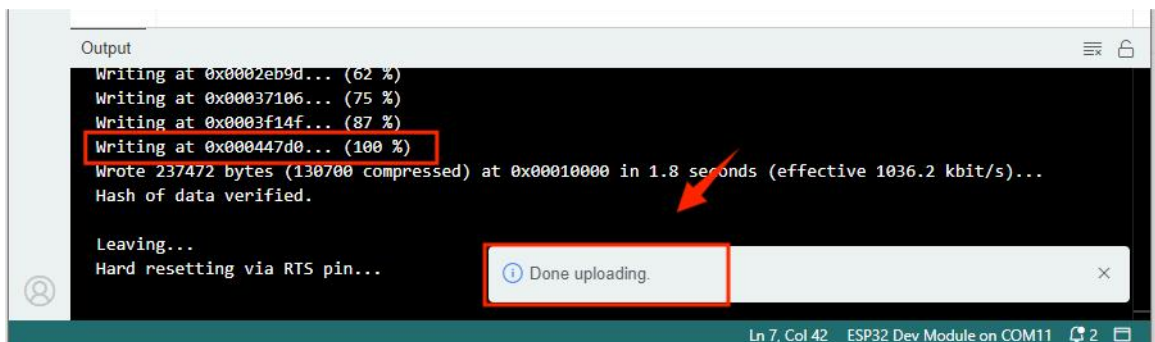

Uploading the program, when the progress display number to 100%, upload program ends.

```
Output
Writing at 0x0002eb9d... (62 %)
Writing at 0x00037106... (75 %)
Writing at 0x0003f14f... (87 %)
Writing at 0x000447d0... (100 %)
Wrote 237472 bytes (130700 compressed) at 0x00010000 in 1.8 seconds (effective 1036.2 kbit/s)...
Hash of data verified.
Leaving...
Hard resetting via RTS pin...
```

Ln 7, Col 42 ESP32 Dev Module on COM11

After uploading the program, the following effect will appear:  
the LED module will gradually light up and then gradually  
extinguish.



Dr. Lumi looked at the street lamp, which seemed to come to  
life. "Well done," he said. "The brightness of the street lamp  
gradually increased and then gradually decreased.

## THE COUNTDOWN: 16 HOURS

### Task 3: Save energy! Let's add a switch to control the light

"Dr. Lumi, the street light keeps flashing. How can I turn it off?"

"It's easy. You can put a button in the circuit then you can turn the light on and off," says Dr. Lumi, pointing to a button.

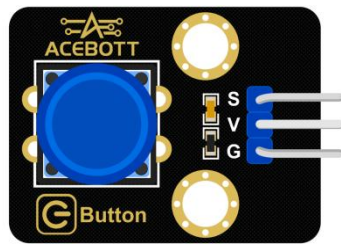

"Dr. Lumi, I've seen it, but I don't know how to use it." You look at the button module and feel confused.

Dr. Lumi opened the projection screen on his arm and said, "Let's see what we know about the button module."

#### Button Module

Button module is a common electronic component used to implement push-button switch operation in electronic devices.

The button module is composed of two electrode pieces and a spring button, the button is located between the two electrode pieces.

When the button is not pressed, the two electrodes of the button are disconnected, and the circuit is in the disconnected state; When the button is pressed, the two electrode pieces touch, forming a closed circuit.

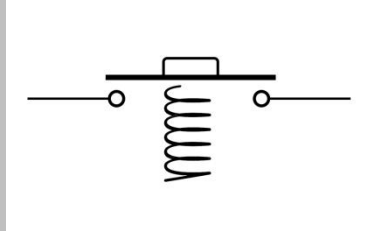

"What's the difference between the button module and the LED module?"

#### **Input module and output module**

1. Input module: it refers to the signal transmitted to the control board through digital or analog pins from external devices (such as buttons, switches, sensors, etc.), and the control board can obtain the state information of the external environment according to these signals, such as key modules, various sensor modules, etc.

The pin on the control board used to get external information should be set to `pinMode (pin, INPUT)`.

2. Output module: refers to the process of sending signals or control information from the control board to external devices, and these output signals can be used to control LED lights, RGB lights, etc.

"So the key module is the input module, how to control the LED light through the key module?"

"You can get the switch signal through the main control system, and then make a judgment to control whether the light is on or off."

Dr. Lumi glances at his arm and opens the 3D projection screen.

"It's going to be more and more to learn, but it's also going to be more fun. Be prepared."

"Ok, Dr. Lumi, I'm ready."

```
volatile int buttun=0;// define a global variable named 'button'
void setup() {
  pinMode(5, OUTPUT);// set pin 5 as output for controlling the LED
  pinMode(26, INPUT); // set pin 26 as input for reading the button state
}
void loop() {
  if (digitalRead(26) == 0) { // check if the button is pressed (low level)
    while (digitalRead(26) == 0) {
      delay(200);// use delay to debounce the button and wait until it's released
    }
    buttun++; // increment the button count
    if (buttun % 2 == 1) {
      digitalWrite(5,HIGH);//if the button press count is odd, turn on the LED
    } else if (buttun % 2 == 0) {
      digitalWrite(5,LOW); // if the button press count is even, turn off the LED
    }
  }
}
```

Of course, there's a simple way to open this hyperlink directly to the program: [Click to get the light on and off program.](#)

After uploading the program, the following effects will appear: press the key module for the first time, and the LED module will light up; Press it again, and the LED module goes out.





"It works. Press the switch and the street light will come on, Dr. Lumi." "You say happily.

## THE COUNTDOWN: 15 HOURS

### Task 4: Add eyes to the street lamp

"Dr. Lumi, have you finished the repair of the street lamp?" It looks like a normal LED lamp.

Dr. Lumi, shaking his head, said, "We haven't finished the repair of the street lights yet. For a smart home, the lighting system needs to be more intelligent, such as when we approach, it will automatically light up, when we move away, it will automatically turn off."

"How do we do that? Dr. Lumi." You look at the component in front of you, trying to figure out that particular component.

"It's easy. Use it." Dr. Lumi was holding a human infrared sensor(PIR sensor).

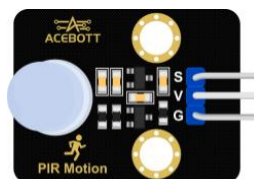

**PIR sensor**

Human infrared sensor is a device that detects human motion based on infrared radiation. When someone or other hot object enters the sensing range of the sensor, the object will cause changes in infrared radiation, so as to be detected by the sensor.

The characteristic of the sensor is that only when the external radiation causes the temperature change of the sensor itself, the corresponding electrical signal will be output. When the temperature change becomes stable, the signal output will not be generated anymore, so it is only sensitive to the human body in motion.

In addition, when the human body is sensed, the sensor will output a high voltage signal with a delay time. If the human body is still present in the sensor range, the sensor will continuously maintain a high voltage signal. Only when the human body leaves, the delay ends and the sensor signal will turn to low voltage.

"How do you control it?" You ask, looking at the body's infrared sensor.

"The writing idea of the code is the same as the key module, through the main control system to obtain the information of the human body infrared sensor, determine whether there is someone around, if there is someone, the light is on; If no one is there, turn off the lights, "says Dr. Lumi, turning on the projection screen.

```
void setup() {
  pinMode(5, OUTPUT); // set pin 5 as output for controlling the LED
  pinMode(14, INPUT); // set pin 14 as input for reading the PIR sensor signal
}
void loop() {
  if (digitalRead(14) == 1) { // if the PIR sensor detects a person (signal is 1),
  turn on the LED
    digitalWrite(5, HIGH);
  }
  else if (digitalRead(14) == 0) { // if the PIR sensor does not detect a person
  (signal is 0), turn off the LED
    digitalWrite(5, LOW);
  }
}
```

Of course, there's a simple way to open this hyperlink directly to the program: [Click to get the PIR lamp program.](#)

When the program is uploaded, the following effect will appear: when someone approaches and shakes, the LED lights up.



"Dr. Lumi, I made it," you say excitedly, looking at the streetlight. "It turns out these electronic modules are so interesting."

## THE COUNTDOWN: 14 HOURS

### Task 5: The Secret in the Light

"Now the street lights can see if someone is passing by, but there is no way to tell how bright or dark the surroundings are. Next, I'm going to introduce you to an amazing sensor, the light sensor."

You look at the light sensor in your hand and ask, "Dr. Lumi, what is a light sensor?"

"A light sensor is a device that determines whether the environment is light or dark," says Dr. Lumi, looking at his surroundings.

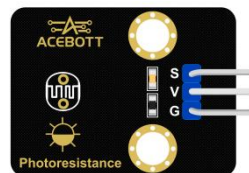

#### Light sensor

A light sensor is a sensor used to detect the intensity of ambient light, which is used to measure the characteristics of light in various scenes.

The light sensor uses the resistance value of the light sensor to change with the change of light intensity. When the light shines on the photoresistor, the resistance value decreases. In low light or dark environments, the resistance value increases. By measuring the change in the resistance value, the intensity of the light can be determined.

"But the intensity of light is not just light and dark, it is a continuous state," says Dr. Lumi cheerfully.

"I don't really understand how it compares to the signal characteristics of the button module," you ask in doubt.

### Digital signals and analog signals

#### 1. Digital signal

A digital signal is a discrete signal that can only take a finite number of discrete values. In digital signals, the value of the signal is determined at different points in time and is usually expressed in binary form, mean 0 and 1. In simple terms, a digital signal is a signal with only two opposing states.



#### 2. Analog signal

Analog signal is a kind of continuous signal, which can take any continuous value in time and amplitude. In analog signals, the value of the signal can be at any amplitude level at any time and can be represented as a continuous waveform. Analog signals are characterized by continuity and infinite accuracy, and are suitable for applications with continuous changes in audio, video, sensor signals, etc.

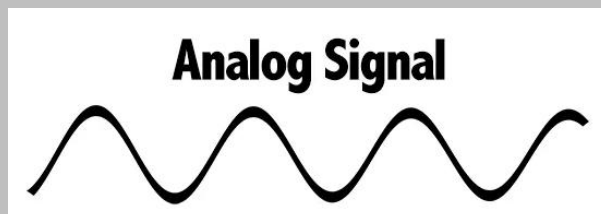

"So how can you see the change in the input data of the light sensor?" "You ask in puzzled.

"When the data is transferred to the main control system, there is a serial monitor for observation, so we need to use the code to get the information from the light sensor, and then read the information from the serial monitor," Dr. Lumi said, open the projection on his arm to reveal the code.

```
void setup(){
  pinMode(32, INPUT);//set pin 32 as input for reading the photosensitive
  sensor
  Serial.begin(9600);//configure the baud rate of serial communication
}
void loop(){
  Serial.println(analogRead(32)); //configure the value of the photosensitive
  sensor on the serial monitor
  delay(1000);
}
```

Of course, there's a simple way to open this hyperlink directly to the program: [Click to get the light sensor program.](#)

"After the program is uploaded, open the monitor icon and you will see the real-time information obtained by the sensor."

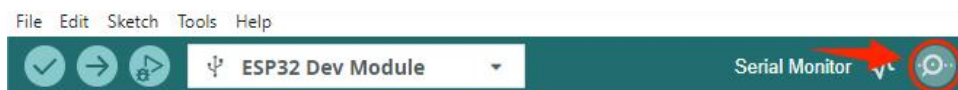

At the same time, if light shines on the photosensor, the value of the serial port monitor will become smaller.

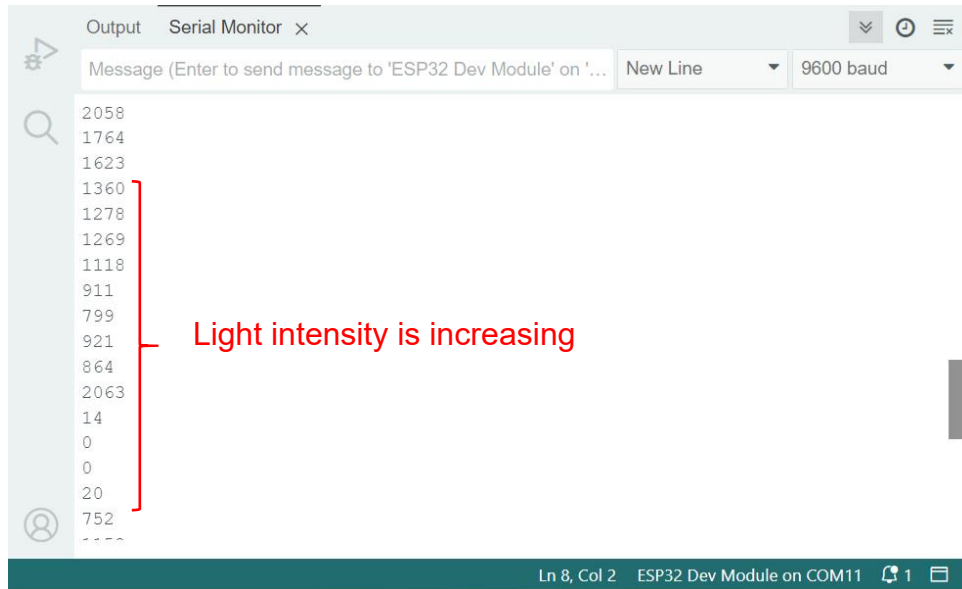

"Dr. Lumi, I have observed the change in the input data of the light sensor after the light irradiation, and what can the light sensor be used for?" you ask puzzled, "the street lamp can already light up when people are passing by."

"The street lights also come on during the daytime when people are passing by, but using light sensors allows the lights to come on when it's dark and there are people around." Dr. Lumi explains.

"I see, Dr. Lumi, and next, shall we plug the light sensor into the circuit of the street lamp?"

"Yes, let's improve the function of smart street lights."



## THE COUNTDOWN: 13 HOURS

### Task 6: It's dark and someone please light up

Dr. Lumi raised his arm and turned on the projection device, revealing the items needed for a smart street lamp.

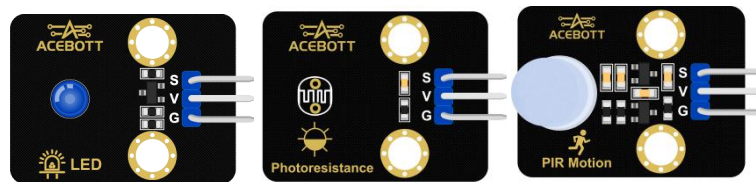

Dr. Lumi went on to say: "The so-called intelligence is to make the robot's behavior more realistic logic, by the control system independent judgment, such as the guardian shield, it can be manually opened, but this is only to confirm whether the function can be used, the real open way need to use voice to communicate with the control board, controlled by the control board self-opening, in order to really open the guardian shield."

"Repairing the Shield is so complicated," you say with a bit of frustration.

Dr. Lumi touches your head and says reassuringly, "It sounds complicated now, but you'll learn to master it, find it fun, and even create your own work if you want."

"I'll try, Dr. Lumi."

Then you asked, "What kind of code instructions should be given to the main control system for this smart street lamp?"

Dr. Lumi switched the projection's display to reveal the current instructions.

```
void setup(){
  pinMode(14,INPUT);// set pin 14 as input for reading the PIR motion
  sensor
  pinMode(32,INPUT);// set pin 32 as input for reading the light sensor
  pinMode(5,OUTPUT);// set pin 5 as output for the LED
}
void loop(){
  if (digitalRead(14) == 1 && analogRead(32) > 2000) {
    digitalWrite(5,HIGH);// turn on the LED if motion is detected and light
    level is above 2000
  } else {
    digitalWrite(5,LOW);// turn off the LED if motion is not detected or light
    level is below 1000
  }
  delay(100);
}
```

Of course, there's a simple way to open this hyperlink directly to the program: [Click to get the nighttime human sensing light program.](#)



The following effect will appear when the program is uploaded:  
When it is dark and someone passes by, the LED light will turn on,  
otherwise the LED light will go out.

"The smart street light is finished", you test and find only "great,  
you have discovered the mystery, the sensor is like our human  
senses."

"But a sensor can only pick up one type of signal."

Dr. Lumi looks at you with relief and says, "That's why we need  
to understand so many different kinds of sensors, because each  
one does something different."

## THE COUNTDOWN: 12 HOURS

### Task 7: Test whether the Shield works properly

Dr. Lumi looked at the bright courtyard and said, "Is it time to see if the shield is working?"

"Doctor, where is the shield?" you look at the yard.

"Here," says Dr. Lumi, pointing to a model. Dr. Lumi turns on the projector in his hand to reveal the pattern of the components.

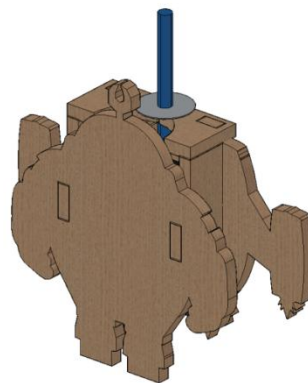

#### Laser Module

The laser module is composed of a 650nm red laser diode head, a drive circuit and three male pins, whose role is to produce a red dot laser beam. It should be noted that the laser has a powerful energy and a highly concentrated beam, the laser beam will cause damage to the human eye, do not direct laser eyes.

The control board can light the laser by output a high level to the laser transmitter module, and a low level means that the laser is turned off.

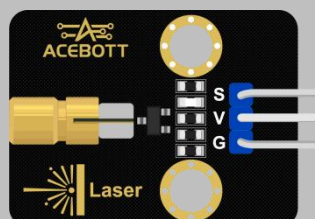

"How do you test if the Shield works?"

"We need to give it instructions," Dr. Lumi said, switching the projection. "You can refer to this code."

```
void setup() {  
  pinMode(23, OUTPUT); // set pin 23 as output for the laser  
}  
void loop() {  
  digitalWrite(23, HIGH); // turn on the laser by setting pin 23 to a high state  
  delay(5000);  
  digitalWrite(23, LOW); // turn off the laser by setting pin 23 to a low state  
  delay(1000);  
}
```

Of course, there's a simple way to open this hyperlink directly to the program: [Click to get the Guardian Shield test program.](#)

**Note: The Guardian Shield emits strong energy, do not let the red energy light directly into your eyes.**

The following effect will appear when the program is uploaded:  
The laser module will light up.

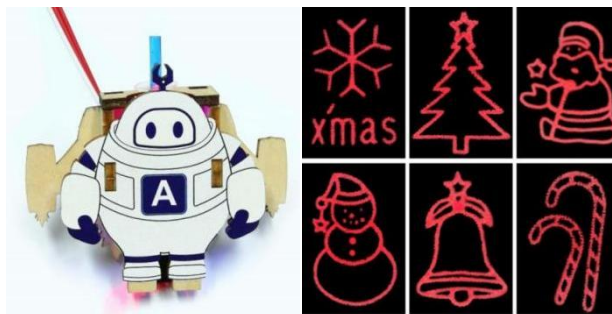

You happily say: "Success, the shield is not damaged and can be used."

"If you turn the plate and look up, you can see different shapes of the shield," says Dr. Lumi, pointing to the small transparent plate.

Dr. Lumi said: 'Now that we have confirmed that the Shield works, the next step is to repair the Mirror.'

## THE COUNTDOWN: 11 HOURS

### Task 8: The secrets of the Time Mirror Light

"Dr. Lumi, the time mirror light doesn't seem to have much to do with the whole system."

Dr. Lumi smiled and replied, "The time mirror light contains a secret device called---the Smart Library, and the smart library can simplify the amount of code you need to write control programs."

You come to the other side of Lumi's Smart Home, where a huge device is placed that looks like a mirror.



Curious, you ask, "Is this the time mirror?" It looks like a normal mirror."

Dr. Lumi nodded, "Yes, this is the time mirror. We now need to repair it and find the secret device hidden inside, and now I will show you the split image of the Time Mirror, the core of the Time mirror is the RGB strip and the round lens."



### RGB RGB Strip

The RGB light strip usually consists of multiple RGB lights arranged at certain spacing and connected to the circuit board.

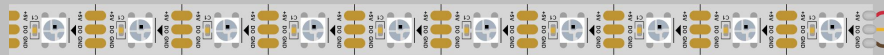

The internal structure of the RGB lamp is as follows. Each lamp contains red, green and blue three different colors of the small lamp beads. When the internal three small lamp beads are matched with different brightness, it is similar to mixing the three colors in different proportions, and the final external display is the mixed light color.

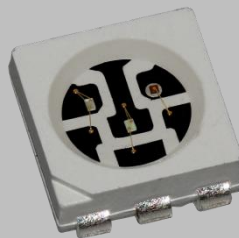

You look at the ribbon and feel confused. You ask Dr. Lumi, "It seems difficult to fix the mirror. I don't know how to mix the colors I want."



### The principle of optical primary colors

The principle of optical primary colors is that in optics, red, green, and blue light are considered the basic colors that blend out all other colors. This principle is based on the perception mechanism of the human eye. There are three different types of cone cells in the human retina, which have different relative sensitivities to red, green and blue light respectively. Therefore, we can produce various colors of light by controlling the intensity ratio of red, green and blue light, thus showing a variety of color sensations.

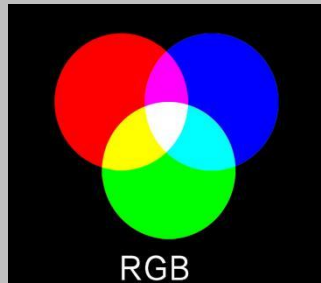

"Do we need to control each bead to control the color?" I asked, confused.

Dr. Lumi smiled. "That would be too much trouble, so here is the secret device hidden in the Time Mirror Light -- the intelligent library, with which complex devices can be controlled in the simplest way."

"Where can I find this library?" you say with relief.

There's a simple way to open this hyperlink directly to the program: [Add instructions for using the library.](#)

You follow Dr. Lumi's instructions, open the instructions, and install the smart libraries into the main control system's dialog tool, the Arduino IDE.

"The smart library has been successfully installed," Dr. Lumi said, pointing to the screen that had been switched. Now enter the command to open the time mirror, you can refer to this command."

```
#include <Adafruit_NeoPixel.h> // reference to imported wait related library
Adafruit_NeoPixel rgb_display_16 = Adafruit_NeoPixel(10,16,NEO_GRB +
NEO_KHZ800); //configure the pins and number of lights of the strip
void setup() {
  rgb_display_16.begin(); //initialization of light strip
}
void loop() {
  rgb_display_16.setBrightness(100); //configure the brightness to 100
  for (int i = 1; i <= 10; i++) { //configure all lights to be blue
    rgb_display_16.setPixelColor((i)-1, (((0 & 0xffff) << 16) | ((0 &
0xffff) << 8) | 128));
  }
  rgb_display_16.show(); // let the light up configuration take effect
  delay(3000);
  rgb_display_16.setBrightness(0); //configure the brightness of the
strip to 0
  rgb_display_16.show(); // let the brightness is 0, that is, turn off the
light of the configuration to take effect
  delay(1000);
}
```

Of course, there's a simple way to open this hyperlink directly to the program: [Click to get the Time Mirror Light test program.](#)

When the program is uploaded, the following effect will appear:  
The mirror of Time Mirror Light will glow blue.



Dr. Lumi said with satisfaction, "Great! Time Mirror restored."

## THE COUNTDOWN: 10 HOURS

### Task 9: It's starting to rain. Come in!

"It's raining, Dr. Lumi."

Dr. Lumi hears your warning and looks up at the sky. "It's raining," he said. "Come in. Time to test out our raindrop sensor! It helps us monitor rain conditions."

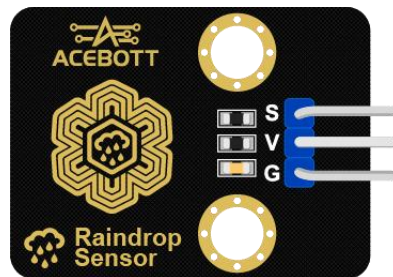

"Dr. Lumi, how does a raindrop sensor detect rain?"

Dr. Lumi presses a button on the robotic arm, and the screen immediately displays information about the raindrop sensor.

#### **Raindrop Sensor**

Raindrop sensor is a device used to detect the falling of raindrops, which is often used in automotive, smart home, and meteorological fields. It is able to sense the presence of precipitation and trigger the corresponding action or feedback.

The working principle of the raindrop sensor is to sense the landing of raindrops through the resistance between two electrodes. When the raindrops land between the electrodes to form a conductive path, the resistance value will change accordingly, and the sensor determines whether there is a raindrop by measuring the resistance change.

Dr. Lumi explained: 'When a raindrop hits the sensing area of the raindrop sensor, the main control system determines that there is rain and closes the window automatically.'

"What tools do you need to close Windows automatically?"

"You need servo motor module," says Dr. Lumi, pointing to the blue device. "You can do it with a simple rack and pinion structure."

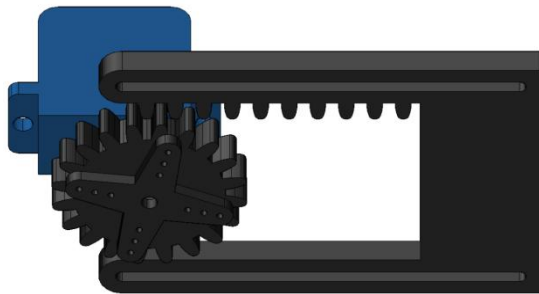

### Micro Servo motor

The main structure of the servo is shown in the following figure, which mainly has several parts: shell, variable speed gear set, motor, adjustable potentiometer, control board, and steering wheel.

Its working principle is that the control board receives the control signal from the signal source and drives the motor to rotate; The gear set reduces the speed of the motor by many times, and magnifies the output torque of the motor by corresponding times, and then outputs; The potentiometer and the last stage of the gear group rotate together to measure the rotation Angle of the servo shaft; The circuit board detects and judges the steering gear rotation Angle according to the potentiometer, and then controls the steering gear to rotate to the target Angle or stay at the target Angle.

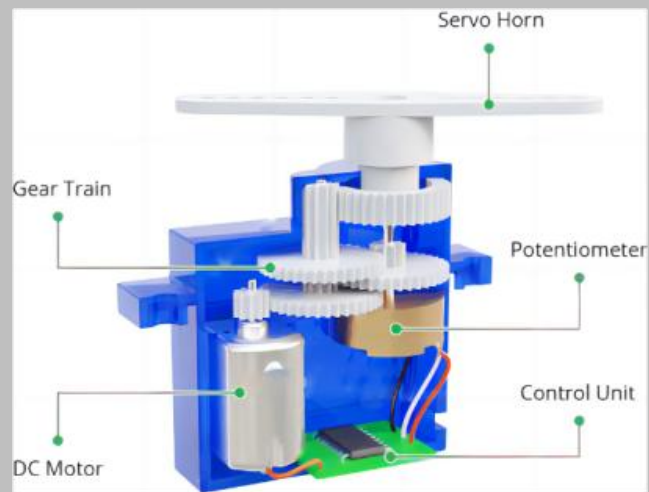

The workflow is as follows: control signal → control board → motor rotation → gear set deceleration → steering wheel rotation → position feedback potentiometer → control circuit board feedback.

"Got it, Dr. Lumi, what kind of code will close the window when it rains?"

Dr. Lumi gestures, and the screen immediately switches to show the code: "You can refer to this code."

```
#include <ESP32_Servo.h>//call servo's library
Servo servo_17;//configure the servo's pins
const int window_close=60;//configure the angle of the servo's window
const int window_open=123;//configure the servo window opening angle
void setup() {
  Serial.begin(115200);
  pinMode(33, INPUT);//initialize pin 33 as the pin of raindrop module
  servo_17.attach(17,500,2500);//initialize servos
  servo_17.write(window_open);//configure the servo initial position
  delay(500);
}
void loop() {
  Serial.println(analogRead(33));
  if (analogRead(33) > 2000) { // raindrop module is dropped on water
droplets will be higher than 2000 values
    servo_17.write(window_close); //close the window when it rains
    delay(500);
  } else {
    servo_17.write(window_open);//open the window when it stops raining
  }
}
```

Of course, there's a simple way to open this hyperlink directly to the program: [Click to get the raindrop window closure program.](#)

After the program upload is completed, the servo will be calibrated first. After calibration, the servo will be in a static state. At this time, the acrylic window should be open (the far left end), and then manually install the acrylic gear on the servo.

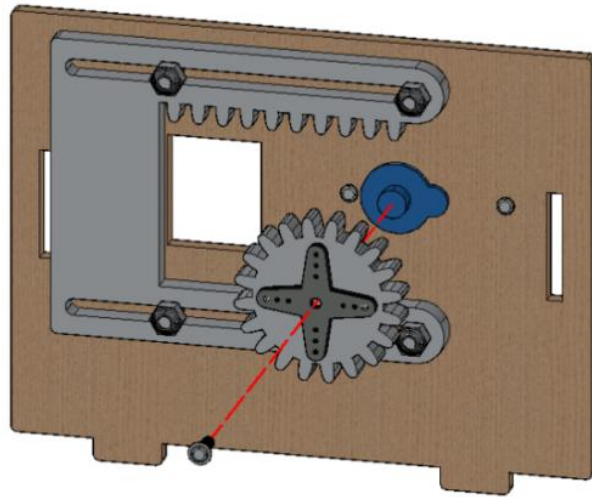

When a raindrop falls (which can be simulated using a drop of water or a wet hand), the window that would have been open closes.

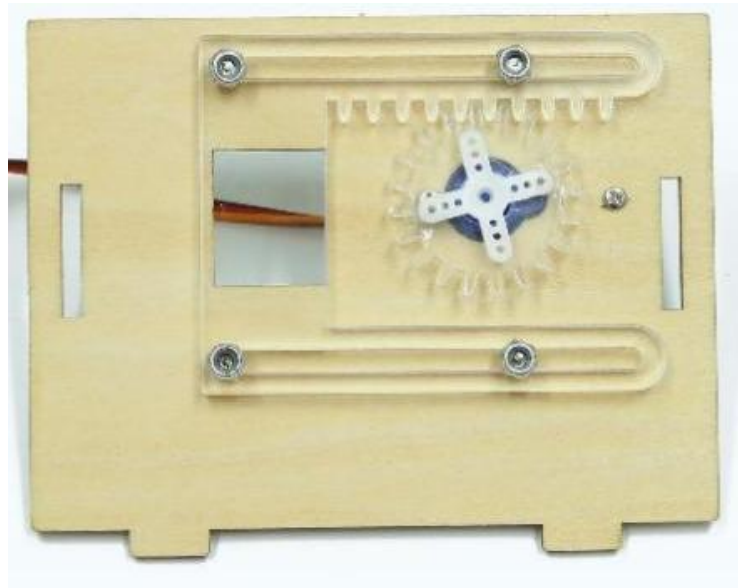



## THE COUNTDOWN: 9 HOURS

### Task 10: The most important part of the Smart Home

Dr. Lumi looked at the roof and asked, "Do you know what the most important part of the Lumi's Smart Home is?"

"Dr. Lumi, I think it's living conditions." You fantasize about lying on a big, fluffy bed.

Dr. Lumi hears your answer and nods in agreement: "Yes, the right living environment is important, especially temperature and humidity, so we need to monitor the temperature and humidity of the living environment."

"This is the temperature and humidity sensor," says Dr. Lumi, pointing to the blue module.

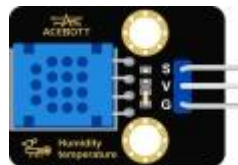

#### DHT11 Temperature and humidity sensor

Temperature and humidity sensor is a sensor based on the digital temperature and humidity sensor DHT11, it is a combination of temperature and humidity sensor, it converts the physical temperature and humidity through the temperature, humidity sensor and the corresponding circuit into a digital quantity that can be directly read by the data acquisition equipment. The temperature range is  $0^{\circ}\text{C} \sim 50^{\circ}\text{C}$ . The accuracy is  $\pm 2.0^{\circ}\text{C}$ , the humidity range is  $20\% \sim 80\%$ , and the accuracy is 5%.

"Dr. Lumi, temperature and humidity can't be seen with the naked eye, so how do you know?" You asked Dr. Lumi curiously.

"Remember the way we talked about looking at data through a serial monitor," Dr. Lumi replied.

"Yeah, but this sensor looks complicated to use," you say, still a little worried.

"It's very simple, we've already installed the repository and we just need simple code to use it, you can refer to this," Dr. Lumi said as he opened the projection screen.

```
#include <DHT.h>//references to library for temperature and humidity
modules
DHT dht25(25, 11);//configure temperature and humidity module pin 25,
model DHT11
void setup() {
  dht25.begin();//initialize the temperature and humidity module
  Serial.begin(9600); //configure the baud rate of serial communication
}
void loop() {
  Serial.print("Temperature:");//print the temperature header
  Serial.println(dht25.readTemperature());//print the temperature value
  Serial.print("Humidity:");//print the humidity title
  Serial.println(dht25.readHumidity());//print humidity value
  delay(1000);
}
```

Of course, there's a simple way to open this hyperlink directly to the program: [Click to get temperature and humidity serial port display program](#)

"After the program is uploaded, you can open the icon of the serial port monitor and see the real-time temperature and humidity information obtained." Dr. Lumi said.



You notice that the serial port monitor on the PC screen shows the temperature and humidity data of the current environment.

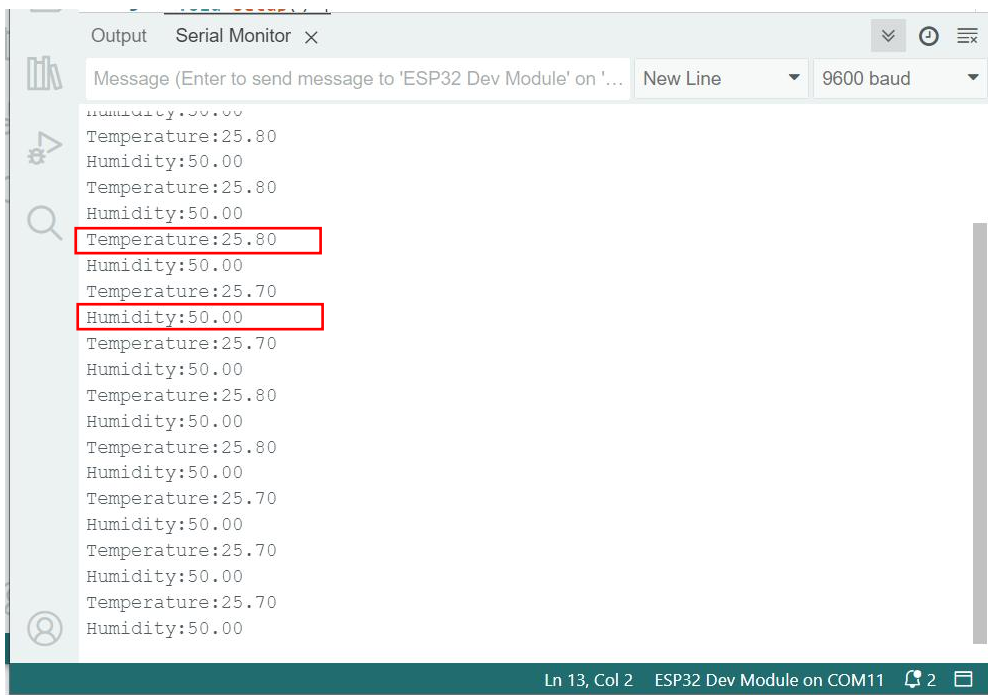

You look at the data and say, "Dr. Lumi, it looks like the Lumi's Smart Home is in a very livable environment right now."

Dr. Lumi smiled and said, "Yes!"

In the midst of the intense repair work, you can't help but wonder what the Lumi's Smart Home will look like when it's resumed and running.

## THE COUNTDOWN: 8 HOURS

### **Task 11: Make the temperature and humidity values visible**

"Dr. Lumi, temperature and humidity data can only be seen through the Arduino serial port every time, which is very troublesome. Is there any other way to see this data quickly?"

Dr. Lumi nodded in agreement and pointed to the huge screen on the cabin. "Yes, LCD screens are a good choice for visualizing temperature and humidity data. We can display the temperature and humidity values on the LCD screen through code."

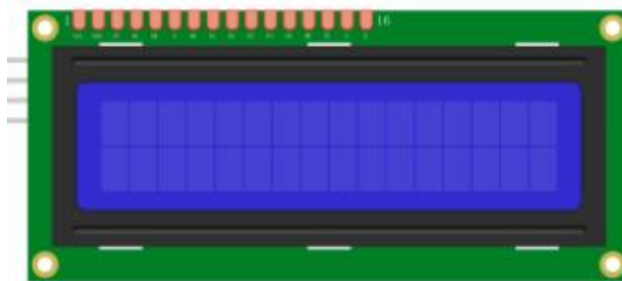

#### **LCD 1602 I2C Module**

LCD (Liquid Crystal Display), a passive display, that is, the liquid crystal itself does not emit light, it needs a backlight source to provide background light brightness, the use of electric field to control the arrangement of liquid crystal molecules, so as to change the light through and block, realize image display.

LCD 1602 I2C Module just as its name implies, this module is consist of 16 characters x2 lines LCD display module (can display 32 ASCII characters), and a module with I2C communication interface, default I2C address 0x27, with a blue potentiometer on the back, Can be used to adjust the backlight (when the character display is not clear, need to adjust the backlight, let the character display clearly).

"The LCD screen is also complicated to use, is there a smart libraries to simplify it?" you ask.

"Yes, the LCD's own smart libraries will simplify things a lot.

You can refer to this code," Dr. Lumi said as he opened the screen.

```
#include <Wire.h>
#include <hd44780.h>
#include <hd44780ioClass/hd44780_I2Cexp.h>
const int i2cAddress = 0x27; // I2C address of the LCD1602
const int numRows = 2; // number of rows in LCD1602
const int numCols = 16; // number of columns in the LCD1602
hd44780_I2Cexp lcd(i2cAddress, numRows, numCols); // create the LCD1602
object
#include <DHT.h>
DHT dht25(25, 11);

void setup() {
  Wire.begin();
  lcd.begin(numCols, numRows); // initialize LCD1602
  lcd.backlight(); // turn on the backlight
  delay(500);
  lcd.clear();
  dht25.begin(); // initialize LCD screen and temperature/humidity module
}
```

```
void loop() {  
  lcd.setCursor(1-1, 1-1);// set the cursor position to the first row and first column  
  lcd.print("T:");// display "T:"  
  lcd.setCursor(3-1, 1-1);// set the cursor position to the third column of the first  
row  
  lcd.print(dht25.readTemperature());// display the temperature value of the DHT  
sensor  
  lcd.setCursor(9-1, 1-1);// set the cursor position to the ninth column of the first  
row  
  lcd.print("H:");// display "H:"  
  lcd.setCursor(11-1, 1-1);// set the cursor position to the eleventh column of the  
first row  
  lcd.print(dht25.readHumidity());// display the humidity value of the DHT sensor  
  delay(200);// delay 200 milliseconds  
}
```

Of course, there's a simple way to open this hyperlink directly to the program: [Click to get temperature and humidity LCD display program.](#)

After uploading the program, the following effect will appear:  
The LCD screen will display the temperature and humidity data.



Dr. Lumi patiently explains: "When the LCD screen is not displaying information, you can turn the blue knob behind the LCD screen with a screwdriver and adjust the brightness of the LCD screen to display information."

You feel happy because the LCD screen will add more intelligent and convenient functions to the Lumi's Smart Home.

## THE COUNTDOWN: 7 HOURS

### **Task 12: The rain has stopped. Start repairing the Gate!**

The rain stopped, and the air outside reeked of fresh grass and rain. You took a greedy breath and felt my fatigue disappear.

You and Dr. Lumi walk out of the cabin and toward the gate of the guard.

The gate is an important part of the Lumi's Smart Home. It not only guarantees the safety of the Lumi's Smart Home, but also symbolizes the solemnity and power of the Lumi's Home.

You and Dr. Lumi watch the gate carefully.

"Dr. Lumi, why not fix the gate in the first place?" You have some doubts inside.

"Remember the smart library in the Time Mirror Light ? The smart library contains the servo library needed to repair the door."

"I see, Dr. Lumi. The mechanical structure of this door seems to me to have seen before. "You look at the guardian gate and feel familiar.

"Look," Dr. Lumi said, opening a projection screen that showed drawings of the door's design.



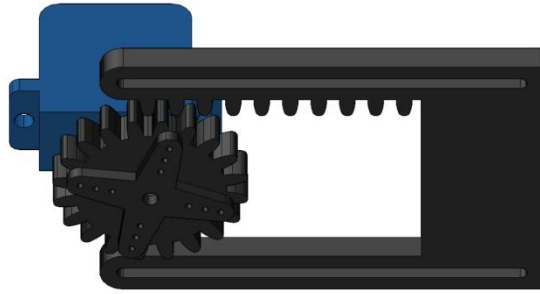

"I see, this door has the same design as the window." You look at the door with a sudden understanding.

"Yes, mechanical structures can be applied to different objects. In the meantime, I will give you the key to the Gate of the Guard, and you will be free to enter the Lumi's Smart Home."

"How do I use the key?" you take the blue keychain and think about how to use it.

"The key needs to be used with the RFID hidden behind the sign of the Lumi's Smart Home."



Dr. Lumi used hand gestures to toggle the display, revealing the relevant RFID information.

**RC522 RFID I2C Module**

Radio-Frequency Identification (RFID) is a technology for wireless identification and tracking of objects. It is based on the principle of wireless communication by using RFID tags and RFID readers to communicate.

**RFID Tag:** An RFID tag is a small chip that contains a unique identifier UID (usually a numerical code) as well as some memory for storing additional information. These tags are usually composed of RFID chips and an antenna.

**RFID Reader:** An RFID reader is an electronic device that generates radio frequency signals and sends them to nearby RFID tags. The reader is also responsible for receiving the response signal from the tag and decoding the tag's information.

**Rf communication:** When an RFID reader sends an RF signal, it activates nearby RFID tags. The passive RFID tag obtains energy from the reader's signal as well as the operation command and uses it to send its own response signal. Active RFID tags have their own power supply, so they can actively send signals.

"I see. When the RFID senses the blue keychain, it opens the door."

Dr. Lumi nodded in satisfaction. "That's it," he said. "You can refer to that for this code."

```
#include <MFRC522_I2C.h> //call the RFID library
#include <ESP32_Servo.h> //call servo library
MFRC522_I2C mfrc522(0x28,-1); //configure RFID address
String rfid_str = ""; //define the variable of string type to read the card number
Servo servo_18; //configure servo pins
const int door_close=5; //define the angle of the door servo to close the door,
which can be modified according to the actual situation
const int door_open=100; //define the angle of the door servo to open the door,
it can be modified according to the actual situation
void setup() {
  Serial.begin(115200); //initialize the serial port, see the card number used to
  Wire.begin(); //initialize i2c serial port
  mfrc522.PCD_Init(); //initialize RFID module
  servo_18.attach(18,500,2500); //initialize servos
  servo_18.write(door_close); //let the servo turn to the initial position
  delay(500); //wait for the end of the servo rotation
}
void loop() {
  if ( ! mfrc522.PICC_IsNewCardPresent() || !
mfrc522.PICC_ReadCardSerial() ) {
//if no new card present or if not successfully read card serial number
  delay(50);
  return; //go back to the main program and start over
}
  rfid_str = ""; //clear the read card number variable first
  for (byte i = 0; i < mfrc522.uid.size; i++) {
  rfid_str = rfid_str + String(mfrc522.uid.uidByte[i], HEX);
  } // store the card number verbatim in the string variable rfid_str
  Serial.println(rfid_str);
  servo_18.write(door_open); //open door
  delay(2000); //wait two seconds, can be changed
  servo_18.write(door_close); //close the door
}
```

Of course, there's a simple way to open this hyperlink directly to the program: [Click to get RFID door opening program.](#)

After the program upload is completed, the servo will be calibrated first. After calibration, the servo will be in a static state. At this time, the acrylic door should be closed (the far right end), and then manually install the acrylic gear on the servo.

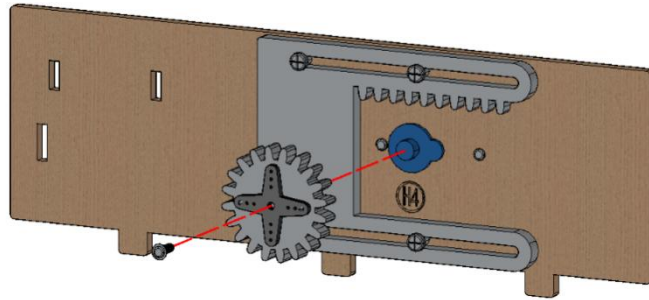

When the card is swiped, the closed door opens and closes again after a few seconds.

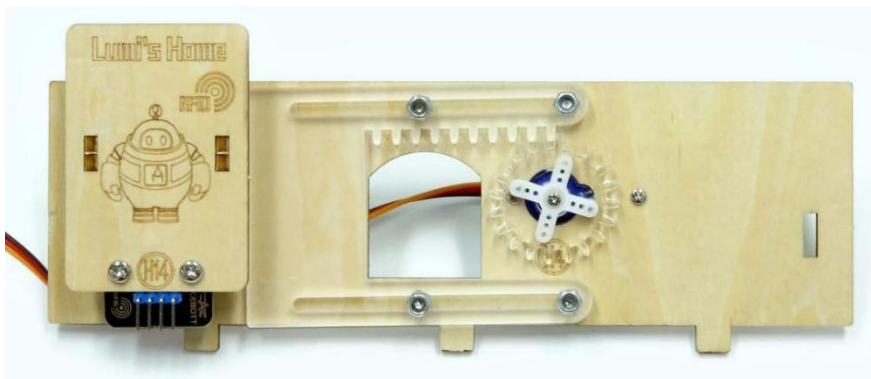

Unconsciously, the door took on a new look. When the final process is done, you and Dr. Lumi stand in front of the gate, proudly admiring your work.

The gate reasserted its majesty and power, like a guardian, firmly guarding the safety of the wisdom Home.

Now that all the devices have been repaired and activated, it's time to test the smart Master voice interaction system.



## THE COUNTDOWN: 6 HOURS

### Task 13: The Guardian's Shield has been launched

"We have finished all the function repair and testing, the next thing is to hand over all the functions to the main control system, and use the voice recognition module to tell the main control system which function to activate." Said Dr. Lumi, standing in front of a large tree and looking up at the top of tree.



"Can it understand me?"

Sure," Dr. Lumi said, turning on the projection screen. "Let's take a closer look at this amazing module."

#### **Voice Recognition Module**

The voice recognition module is an AI offline speech recognition product.

Voice recognition It can understand our words and convert them into words or commands. First it needs to record our words with a microphone, then these recordings are processed, and then these processed recordings are converted into a series of special digital signals. Next, the trained model is used by the machine - it has learned how to associate different sounds with corresponding words or commands, and when we speak, the machine uses this model to guess what we are saying.

It should be noted that the accuracy of voice recognition can be affected by many factors, such as the accent of the speaker, the speaking rate, and the surrounding noise, among others.

"This is wonderful! It looks complicated, but it's easy to use, you say happily.

"Yes, make it easy for everyone.

You shout, "Hi Lumi."

Suddenly from the canopy, a voice said, "Hi, what can I help you."

"Smart Voice has another wake-up response -- Hi, I am here. Keep in mind that the smart voice stays awake for 30 seconds, after which it goes into sleep mode and needs to be reawakened with 'Hi Lumi', "says. Dr. Lumi.

As you and Dr. Lumi stand in the middle of the yard, ready to officially open the Guardian's Shield, you feel a mixture of tension and excitement.

Before we start interacting with the speech recognition module, we need to know the data it converts our words into so that we can control it.

**Data corresponding to speech recognition commands**

In the speech recognition module, we have burned the instructions in advance, and the corresponding data is shown in the following table:

open the door	0x2
close the door	0x3
open the window	0x4
close the window	0x5
open the light	0x8
close the light	0x9
open the laser	0xA
close the laser	0xB
open the color light	0xC
close the color light	0xD

Dr. Lumi walks to the center of the smart home and tells you that he needs your help to type a special instruction.



```
#include <HardwareSerial.h>//call the library for the hard serial port
volatile int audio;//variable storing the voice signal of the serial port
void setup(){
  Serial2.begin(115200,SERIAL_8N1,13,27);//configure rx to be pin 13, tx
to be pin 27, and the serial port name of the voice module is Serial2
  audio = 0;
  Serial.begin(115200);//connect the computer side of the serial port for
Serial
  pinMode(23, OUTPUT);//the pin of laser light
}
void loop(){
  if (Serial2.available() > 0) {/speech serial port receive data or not
  audio = Serial2.read();//store the data from the voice serial port into the
audio variable
  Serial.println(audio,HEX);//use the computer side of the serial port will be
sent to the computer's serial monitor in hexadecimal form of values
  if (audio == 0x0A) {/voice command is open the laser , voice serial port
value is 0x0A, then turn on the laser light
    digitalWrite(23,HIGH);
  }
  if (audio == 0x0B) {/voice command is close the laser, voice serial port
value is 0x0B, then turn off the laser light
    digitalWrite(23,LOW);
  }
}
}
```

Of course, there's a simple way to open this hyperlink directly to the program: [Click to get the voice control program to open the guardian shield.](#)

Dr. Lumi said: 'The smart voice system needs to wake up the smart assistant and then speak the corresponding voice command before it can be used.'

"Hi, Lumi (wake up command). " The Guardian's Shield is now open! Instruction -- "open the laser, "Dr. Lumi announced solemnly.

With his words, the entire smart home began to emit a mysterious wave of energy. You feel an invisible force flowing through the House of Wisdom, like an invisible shield around the Lost city.

You and Dr. Lumi look up at this spectacular sight with pride and joy. The opening of the Guardian's shield signals that the Lost City is safe.

"It's safe," says Dr. Lumi enthusiastically.

Then the communications device in the box rings. It's Mayor Johnny on the phone.

"Dr. Lumi, you have succeeded in activating the Shield. On behalf of the people of the Lost City, I thank you, and we will host a great feast for you and the warriors."

Dr. Lumi looked up at you and tried to talk, but he hung up. Dr. Lumi looked up at you and said, "But it's safe."

You look up at the sky, take a deep breath, and say, "Yeah, it's safe."

## THE COUNTDOWN: 5 HOURS

### **Task 14: Try something new**

"Dr. Lumi, since you can open and close the Guardian shield by voice, why not try to open and close the doors and Windows by voice?" your nervous tension is relaxed, and you can't wait to try to design a new feature.

"Yes," Dr. Lumi replied. "We can add instructions for opening and closing doors to the speech recognition module."

You're excited to imagine that with a simple voice command you can make a window automatically open, allowing fresh air to flow in, or a door automatically open to welcome guests.

"When you give the corresponding voice command, the voice recognition module will interpret the command and send a signal to the smart master system, and then the smart master system will control the corresponding window or door to open or close the command," Dr. Lumi continued.

You can't wait to say, "Dr. Lumi, can I see the instructions?" "Sure," Dr. Lumi said with a smile.

Dr. Lumi raised his arm to open the projection screen and showed the voice control commands of the window and door control modules.

```
#include <HardwareSerial.h>//call the library for the hard serial port
volatile int radio;//variable storing the voice signal of the serial port
volatile int radio_mark=0,radio_time=0;
//configuration of the voice module
#include <ESP32_Servo.h>
Servo servo_17;
const int window_close=60;
const int window_open=123;
//window servo configuration
Servo servo_18;
const int door_close=5;
const int door_open=100;
//door servo configuration
void setup() {
    // put your setup code here, to run once
    Serial2.begin(115200,SERIAL_8N1,13,27);//configure rx to be 13 pins,
    tx to be 27 pins, and the serial port name of the voice module is Serial2
    radio = 0;//store the data from the voice serial port into the radio variable
    //initialization of the serial port of the voice module
    servo_18.attach(18,500,2500);
    servo_18.write(door_close);
    delay(500);
    //initialization of door servos
    servo_17.attach(17,500,2500);
    servo_17.write(window_open);
    delay(500);
    //window servo initialization
}
void loop() {
    radio_controll();
}
/***** voice control program 007*****/
void radio_controll(){
    if ((radio_time!=0)&&((millis()-radio_time)>8000))
    {
        Serial.println("auto_mode");
        radio_mark=0;
        radio_time=0;
    }
}
```

```
if (Serial2.available() > 0) { // whether the voice serial port is receiving data
or not
    radio = Serial2.read(); //store the data from the voice serial port into the
radio variable
    Serial.println(radio,HEX); //use the serial port on the computer side to
send the value in hexadecimal form to the computer's serial port monitor
    Serial.println("radio_mode");
    if (radio == 0x02) {
        servo_18.write(door_open);
    }
    if (radio == 0x03) {
        servo_18.write(door_close);
    }
    if (radio == 0x04) {
        servo_17.write(window_open);
    }
    if (radio == 0x05) {
        servo_17.write(window_close);
    }
}
}
}
}

/***** voice control program 007*****/
```

Of course, there's a simple way to open this hyperlink directly to the program: [Click to get the program for voice control doors and Windows.](#)

You study the instructions carefully. "This is amazing!" After you upload the program, you say excitedly, "I can't wait to try out the new features, can I?"

Dr. Lumi nodded and smiled. "Sure."

You cheerfully walk to a window or door to be tested. You clear your throat and say, "Hi Lumi."

"Hi, what can I help you?"

When the intelligent voice answers, you speak the command:

"open the door."

With your command, the door immediately opens, showing the intelligent control effect. You cheer with excitement and feel the convenience and fun that technology brings.

Dr. Lumi nodded in satisfaction. "Everything looks fine. the command to close the door is' close the door, 'the command to open the window is' open the window,' and the command to close the window is' close the window. 'You can try it yourself."

## THE COUNTDOWN: 4 HOURS

### **Task 15: A magical communication method--WIFI**

You stand in the doorway and call for the Smart Voice. When there is no response, you turn to Dr. Lumi, who is standing under the tree. You ask, "Dr. Lumi, if we are too far away from the smart voice, is there any other way for the master to receive our commands?"

"There is a way, people in order to solve this problem, invented the method of wireless communication -WIFI. The computer/laptop need to connect WIFI, and then connect the ESP32 control board to the same WIFI as the computer/laptop through the program."



"The computer can connect to WIFI with a passcode," you ask incredulously. "How can I connect to WIFI with an ESP32?"

"Just change the ssid and password in the program below," Dr. Lumi said, showing part of the code.

The ssid of your WIFI

```
const char* ssid = "ACEBOTT";
```

```
const char* password = "12345678";
```

The password for your WIFI



"That is to change the ssid(WIFI name) and password (WIFI password) into the same WIFI as the computer or mobile phone", you understand later replied, "Let the computer communicate with the ESP32 master through WIFI, and then enter instructions in the browser's web page to control the ESP32 control board."

"Yes, you understand exactly. Just like writing a letter to someone, you need to write the address, and the computer needs to give the address to receive the instruction. The format is: 192.168.45.111/Test, where 192.168.45.111 is the address (IP address will change depending on WIFI network), "/" is the interval symbol, and Test is the instruction."

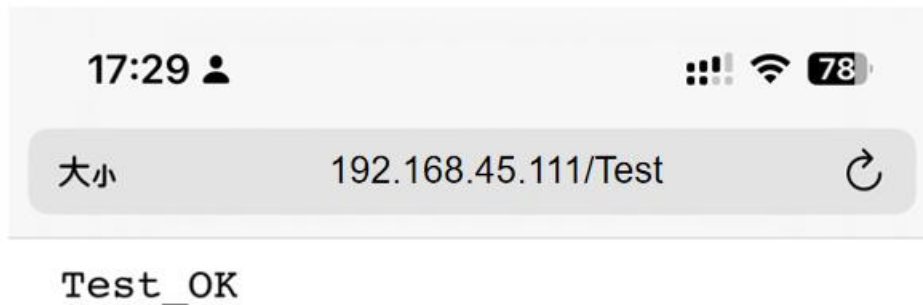

"Looks a bit complicated, how to get the IP address."

"The IP address will be fetched from the code and displayed on the serial monitor," Dr. Lumi reassuringly said.

"Let's try it out. Let's start by controlling street lights." "First let's open the program and change the ssid(WIFI name) and password(WIFI password)."

[Click to get WIFI control LED program.](#)

"Of course, the first you use is difficult, follow the steps strictly, you will understand gradually."

After uploading the program, open the serial port monitor, change the baud rate to 115200, press the reset key of the control board, and the results are shown as follows:

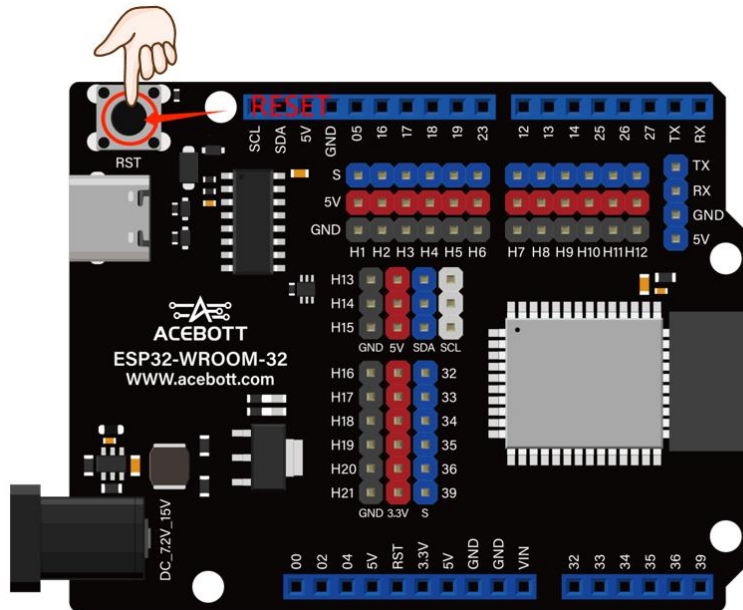
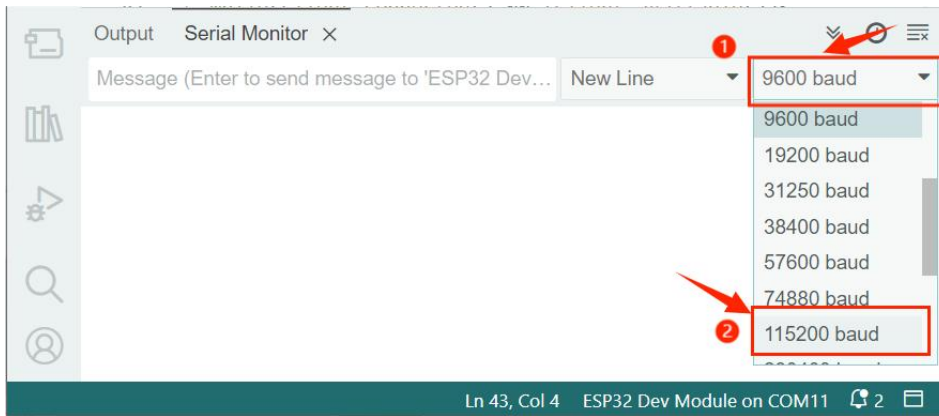

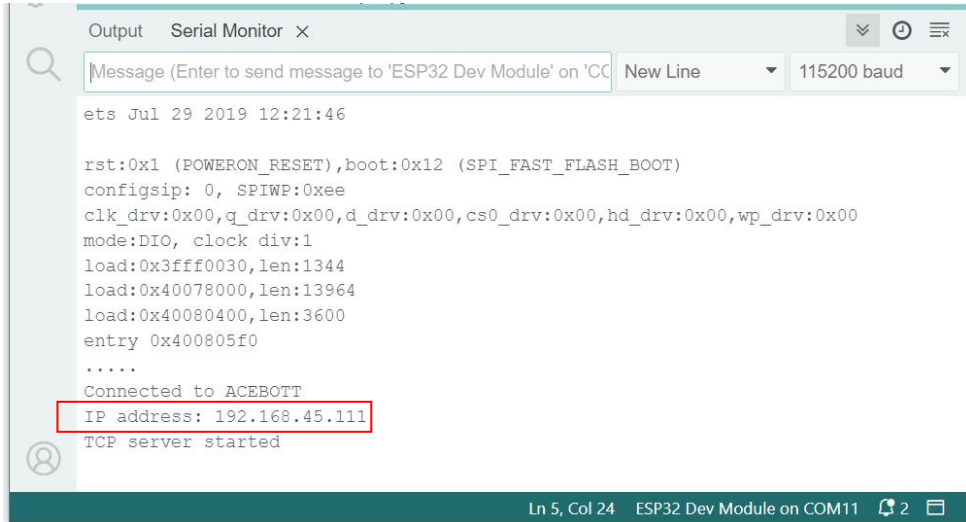

When you type: 192.168.45.111 in your browser's address bar (connected to the same network), it will shown:

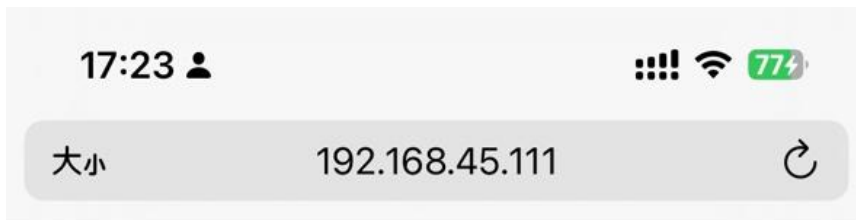

Hello from ESP32 at 192.168.45.111

When you enter: 192.168.45.111/LED\_on in the browser address bar and confirm, the serial port monitor will display as follows, and the LED light will turn on.

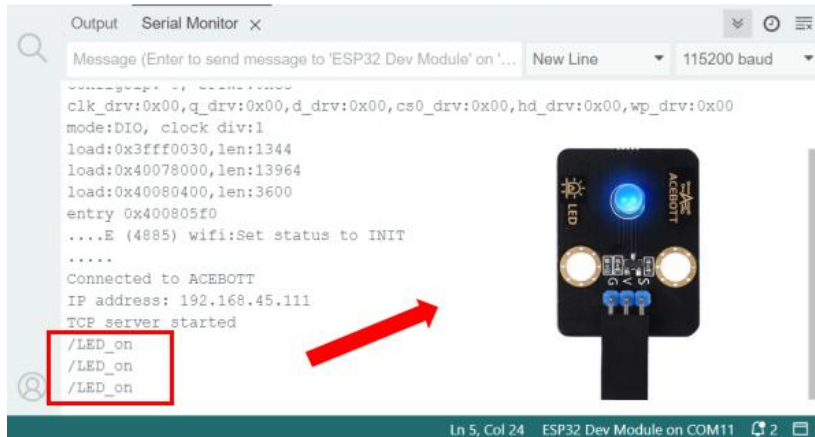
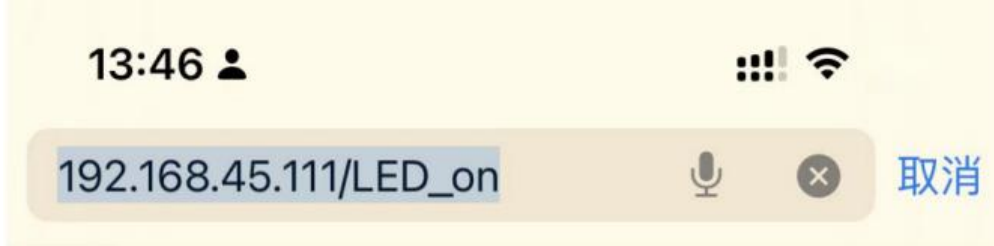

When you enter: 192.168.45.111/LED\_off in the browser address bar and confirm, the serial monitor will display as follows, and the LED light will turn off.

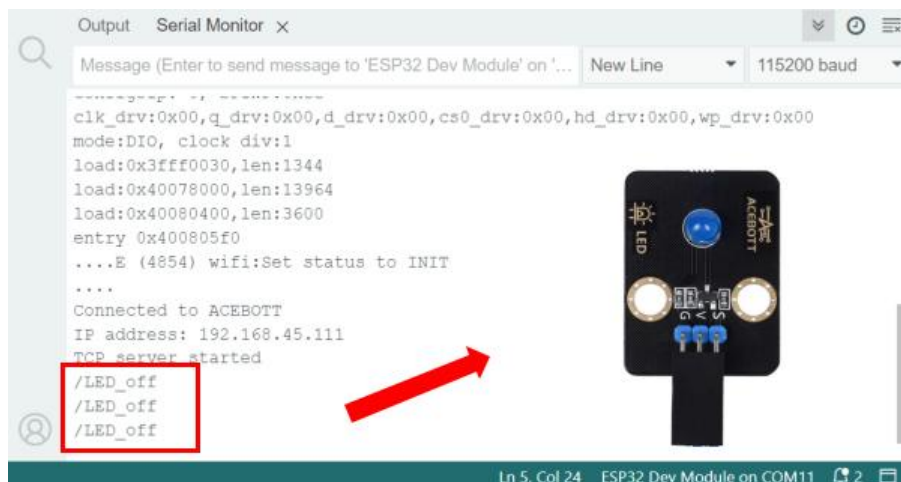
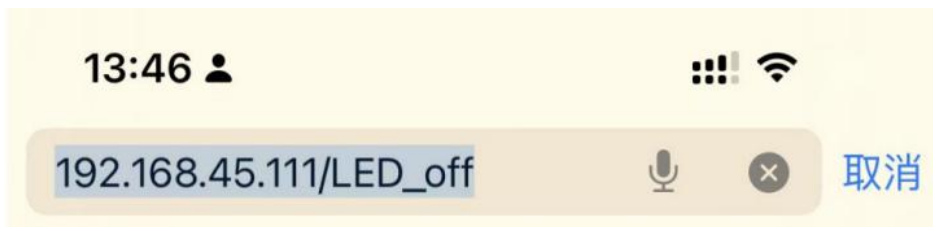

After carefully following the steps to control the LED light in the browser, you have mastered the use of WIFI to control the LED.

You have always thought that WIFI is a magical technology, and now you can master it.

## THE COUNTDOWN: 3 HOURS

### **Task 16: WIFI can also control doors and windows**

Dr. Lumi looked at the sky countdown and felt he had to hurry up and teach the knowledges.

"Next we'll try to use WiFi to control the doors and Windows," says Dr. Lumi, removing a projector from his arm and handing it to you. "From today, this device is here for you. It contains knowledge and instructions.

You take the device and suddenly feel the responsibility:  
"Thank you, Dr. Lumi. I will study hard and take care of the Lost City."

Under the guidance of Dr. Lumi, you learned how to operate the device and successfully call the WIFI command to control the door and window.

Open this hyperlink directly to the program: [Click to get WIFI control doors and Windows program.](#)

After uploading the program, open the serial port monitor, change the baud rate to 115200, press the reset key of the control board, and the results are shown as follows:

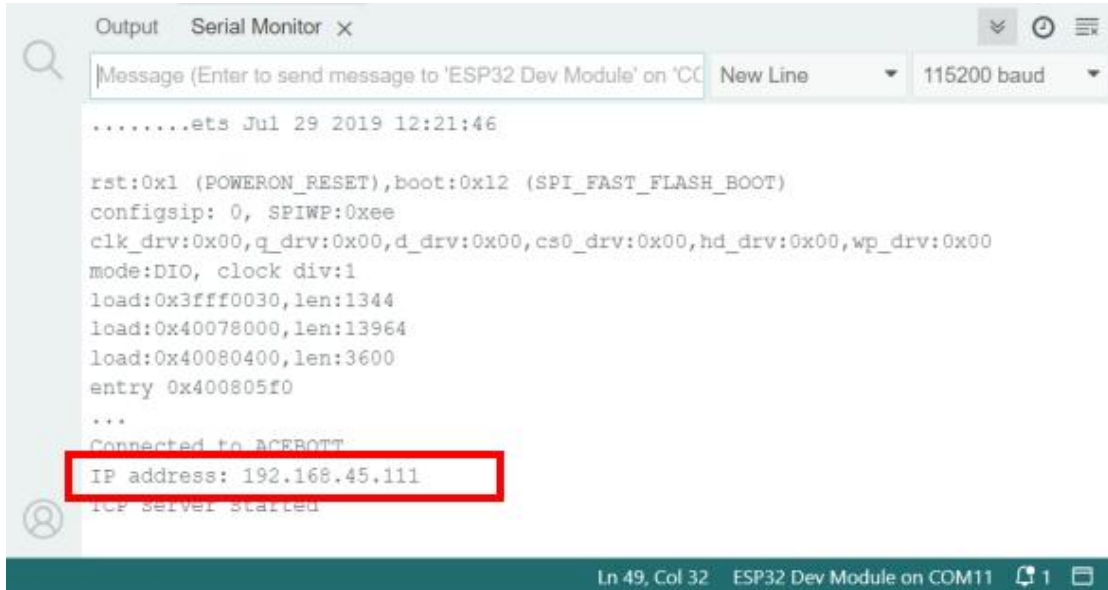

When you type: 192.168.45.111 into your browser's address bar, it will show as follows:



Hello from ESP32 at 192.168.45.111

When you type: 192.168.45.111/door\_on and 192.168.45.111/door\_off in your browser's address bar, it will show as follows:



Remember to click "go" on your phone or "enter" on your computer, then the serial monitor will show as follows:

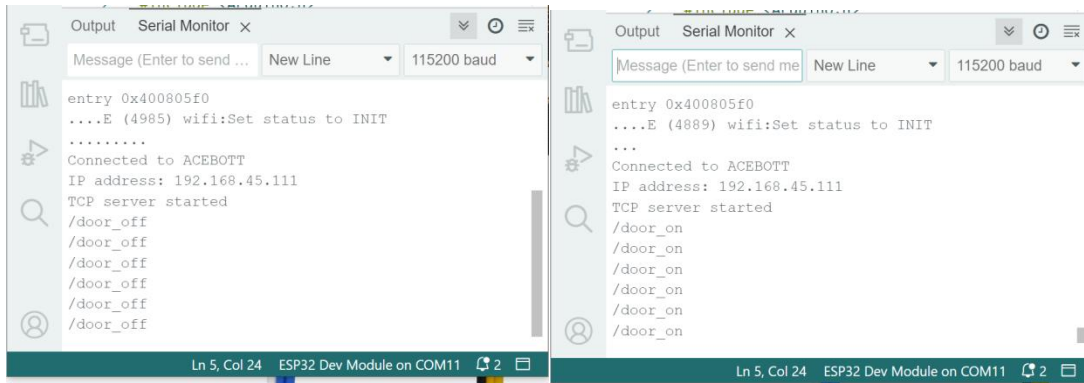

When you type: 192.168.45.111/window\_on or 192.168.45.111/window\_off in your browser's address bar, you get the following:



Remember to click "go" on your phone or "enter" on your computer, then the serial monitor will show as follows:

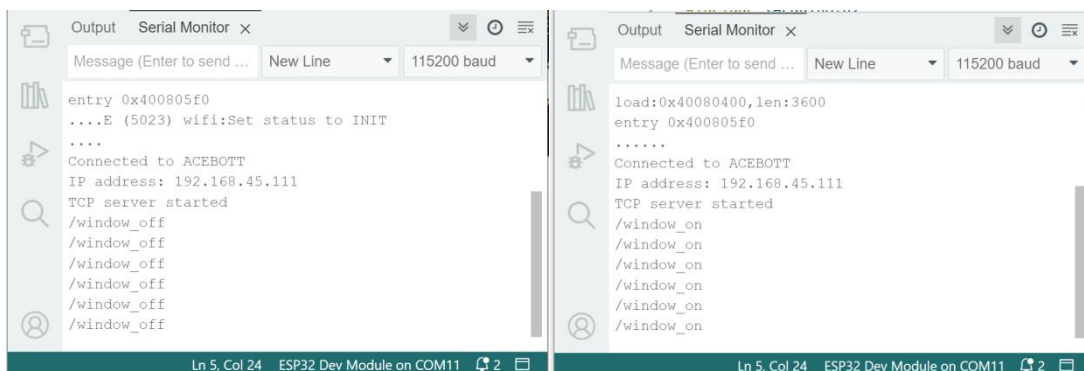



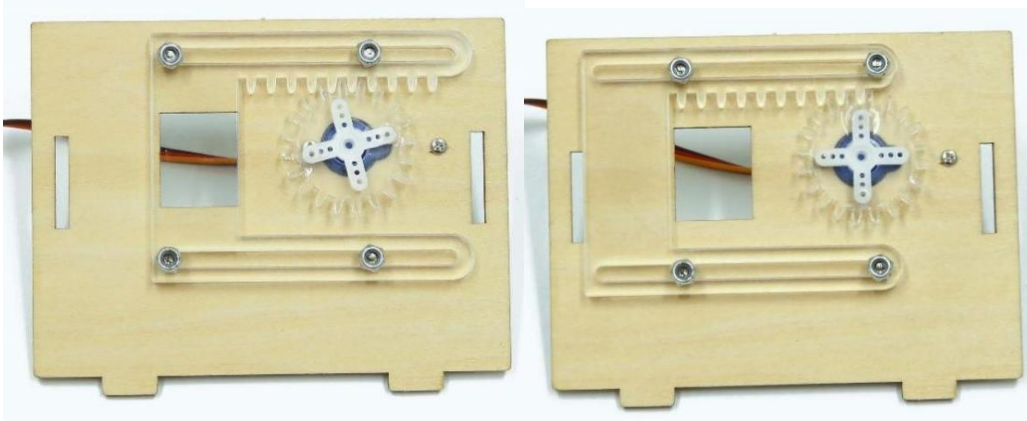

Lumi looks at you as you experiment with the doors and Windows, and reminds you, "You can use your browser to enter the corresponding IP address, send the instructions written in the program, and you can control the doors and Windows to switch."

You reply, "I see, Dr. Lumi, I will follow the procedure carefully."

## THE COUNTDOWN: 2 HOURS

### Task 17: A new interactive control

"Dr. Lumi, if the computer isn't around, is there any other way to control it?"

"Good, that's a great question," Dr. Lumi looks at you with pleasure. "Putting the control system in the phone solves this problem. I prepared an APP that can be installed on my mobile phone, so that you can control the smart home anytime and anywhere."

"How do I install it?"

"You can search for 'ACEBOTT' on your phone's app store, download and install it, this is the ACEBOTT icon." says Dr. Lumi.



"ACEBOTT app is installed, can you directly control the smart home?"

Dr. Lumi shook his head and said, "No, you need to write the control program to the ESP32 control board first, and then the APP can be used. Notice that the phone and the ESP32 need to be connected to the same WIFI."

**Note:** There are two ways for devices to connect to the ACEBOTT mobile app controlling the smart home: ①②: ① The mobile phone and ESP32 can be connected to the same router; ② Turn on the mobile hotspot in the phone settings and let the ESP32 device connect to the hotspot.

① The mobile phone and ESP32 are connected to the same router, meaning they are connected to the same WIFI.



② The mobile hotspot can be activated in the phone's "Settings" under "Personal Hotspot", set up with a hotspot name and password. Then let the ESP32 connect to the personal hotspot.



You adjust the projection equipment and find the relevant program: [Click to get WIFI control program.](#)

"You need to change the SSID(WIFI name) and PASSWORD(WIFI password) in the program to your own SSID(WIFI name) and PASSWORD(WIFI password)," Dr. Lumi warns.

When you're done, upload the program to the ESP32 motherboard.

Then Dr. Lumi said, "Now it's time to download proprietary apps. If you have an IOS phone, you have to search for ACEBOTT in the APP Store and download it.

"How do I download it for Android?"

"If you have an Android phone, you need to search the Google Play Store for ACEBOTT and download it."

Follow this method to download and install the program.

"Dr. Lumi explained, pointing to an icon on the phone's screen.

"You just tap the icon and it will open the app."



"Then you will see is this open screen interface."



"Next you go to the product selection screen, where you select 'Save The Lost City.'"

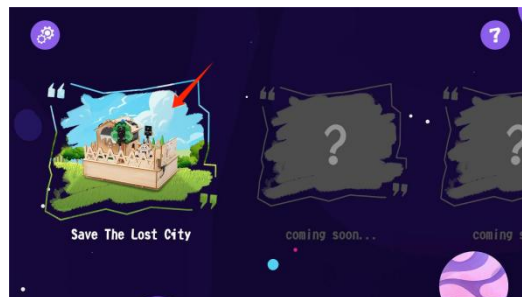

"Once you enter, you will enter the smart home function control screen, and then click the 'ip' icon to connect to the ESP32."



You can enter the IP address in the APP according to the IP address displayed in the serial port monitor and click "connect".

When you see the 'Connected Successfully' prompt, you need to click the cross(X) in the top left corner to get back to the smart home interface."



After the connection is successful, click the corresponding icon to open the corresponding function. If you need to open the Time Mirror Light, you can select the function button :RGB. You will see the Time Mirror Light light up as shown below.

If you need to change the color of the Mirror, you can also drag the feature sliders R, G, B.



You look closely at the phone screen and see a simple and intuitive interface. Each device has an on-off button, and by clicking the button, you can control the state of the device. In addition, there are some additional options such as background music selection, language selection, About us and other functions.

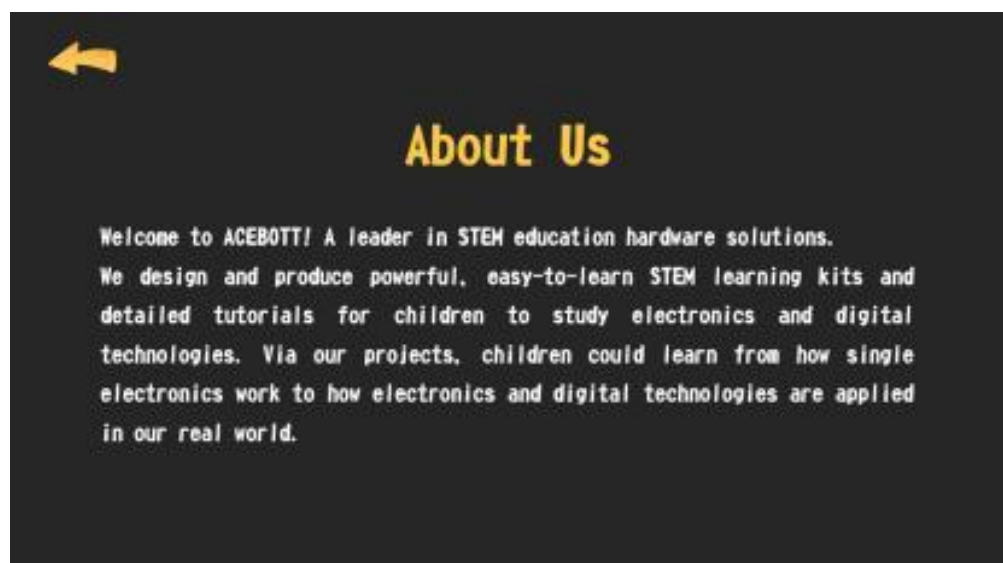
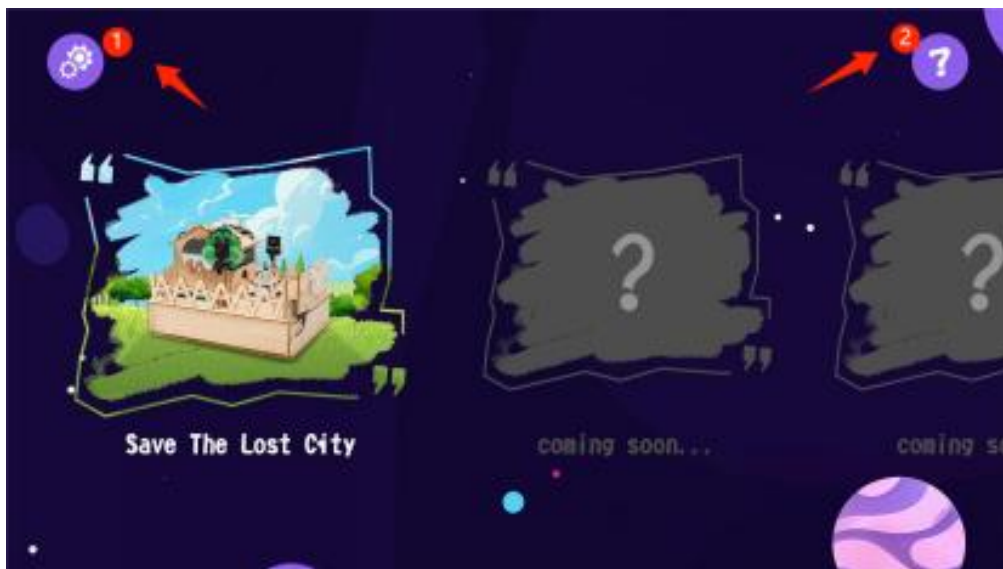
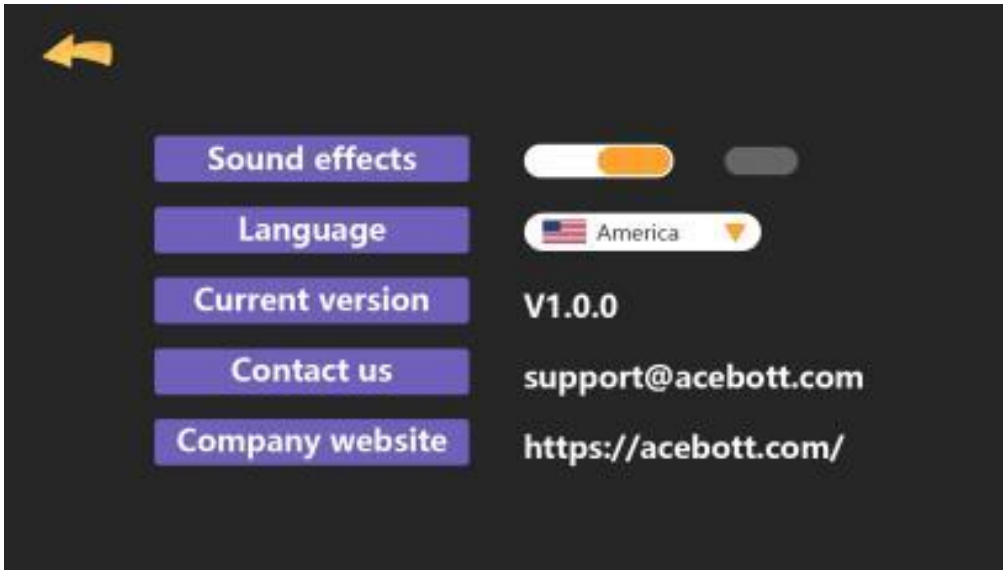



You are very excited and satisfied with the application. This means that no matter where you are, with your phone in hand, you can easily control the main control system via WiFi. Because with this application, you don't need to rely on the computer to control the main control system, but you can operate it anytime and anywhere.

"This is so convenient," you say excitedly, looking gratefully at Dr. Lumi. "Thanks for your guidance and help, Dr. Lumi!"

Dr. Lumi smiles and nods. "You're welcome," he says.

"Remember, it's important to think creatively when you're facing a problem."

You pick up your phone with confidence, ready to explore and use this portable control system.

## THE COUNTDOWN: 1 HOURS

### **Task 18: Leave a gift**

"Dr. Lumi, now that the Lumi's smart home is fully functional and has added many convenient features, it feels like you can finally rest." You breathe a sigh of relief.

Dr. Lumi nodded with satisfaction. "Yes, now we can finally enjoy the rising sun together under the tree."

Then Mayor Jonnhy led the crowd: "Cheers for Dr. Lumi and our warriors!"

Cheers came from the crowd on all sides. Soon, Lumi's smart home is decorated to beautiful and unique -- you can paint it by yourself if you like. Colorful lights twinkle on the walls, and the table is filled with food and drinks.

People gathered happily, and laughter and cheers filled the space. In the laughter, the sun gradually rises, you gather in the courtyard, looking up at the direction of the sun rising, watching the meteorite fall and touch the shield of the moment of fragmentation, people's hanging heart is also put down.

At this moment, the Time Mirror Light suddenly lit up and gave off a dazzling light. Everyone stared in amazement at the entrance full of mysterious power.

The crowd exclaims and asks, "Dr. Lumi, what happened?"

"Well, I must go, The Lost City. Good-bye. Thank you, my warrior, for a thrilling and unforgettable day. Of course I have a little surprise for you. When you think of me, shout out: Adventure Begin."

You look up and see that the countdown to the sky is over and Dr. Lumi is gone, as if it never happened.

Suddenly you remember what Dr. Lumi told you before the party. You run to the tree in the yard. You find a blue wooden box under the tree. When it was opened, a string of code appeared on the wall.

It is Dr. Lumi put it all the function together in a code, so go to this hyperlink: [Click to get voice, WIFI, automatic function collection program.](#)

After uploading the program and testing, it is found that the automatic function, WIFI function, voice function and APP function can be complete in a code.

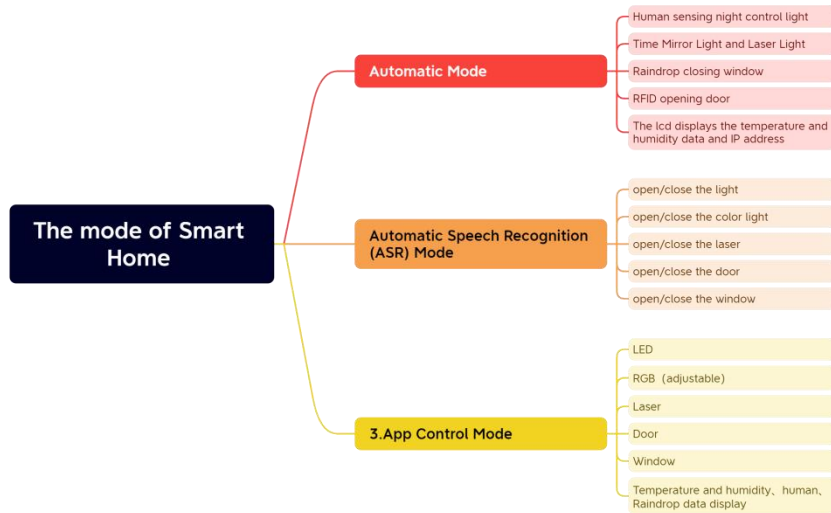

You've also discovered that "Adventure Begin" is actually an instruction.

You pack up your gear, stand in the yard, awaken the Smart Voice, and shout out "Adventure Begin", and suddenly the Time Mirror Light lights up and absorbs you.

What's the next adventure story? What kind of adventure will there be? Stay tuned!